

EST-275 R 4C 1277 4
RICHARD B FONES JR
25 BALTIMORE-ANNAPOLIS
BLVD-FERNDALE
GLEN BURNIE MD 21061

September, 1975 □ 75 cents

Electronic Servicing®



A HOWARD W. SAMS PUBLICATION

Servicing AUDIO SYSTEMS

Scan
Rectification

Station Wagon
Or Van?

Wiring
CB Connectors



Let us solve your tuner problems

PTS will repair any tuner—no matter how old or new. Fastest Service—8 hour—in and out the same day. Overnight transit to one of our strategically located plants. Best Quality—you and your customers are satisfied.

PTS uses only ORIGINAL PARTS! No homemade or make-do, inferior merchandise (this is why we charge for major parts!). You get your tuner back in ORIGINAL EQUIPMENT condition.

PTS is recommended by more TV Manufacturers than any other tuner company and is overhauling more tuners than all other tuner services combined.

We're proud to announce the Grand Opening of our new Service Centers in Los Angeles, Columbus, Ohio, Phoenix, Boston, Norfolk & Indianapolis

Precision Tuner Service



ELECTRONICS, INC.

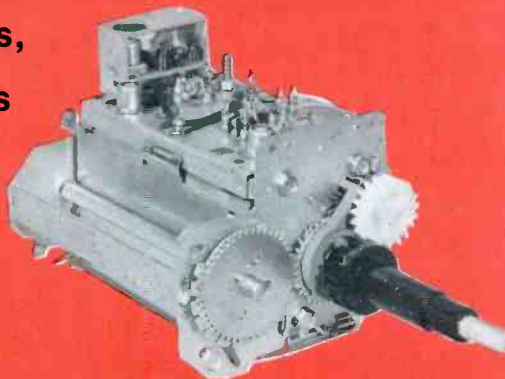

VHF, UHF \$10.95
UV-COMBO 17.95
IF-SUBCHASSIS . . 12.50

Major parts and shipping charged at cost. (Dealer net!)

Home Office	Bloomington, Indiana	47401	5233 S. Highway 37	812-824-9331
Alabama	Birmingham, Alabama	35222	524 32nd St. So.	205-323-2657
Arizona	Phoenix, Arizona	85061	2412 W. Indian School Rd.	602-279-8718
California	Los Angeles, Ca. Central	90023	4184 Pacific Way	213-266-3728
	Sacramento, Ca. No.	95841	4611 Auburn Blvd.	916-482-6220
	San Diego, Ca. So.	92105	5111 University Ave.	714-280-7070
Colorado	Arvada, Colorado	80001	4958 Allison St.	303-423-7080
Florida	Jacksonville, Fla. No.	32210	1918 Blanding Blvd.	904-389-9952
	Tampa, Fla. Cen.	33690	2703 S. MacDill St.	813-839-5521
	Miami, Fla. So.	33168	12934 N.W. 7th Ave.	305-685-9811
Indiana	Bloomington, Ind.	47401	5233 S. Highway 37	812-824-9331
	Indianapolis, Ind.	46202	28 East 14th St.	317-631-1551
	Kansas City, Kansas	66106	3116 Merriam Lane	913-831-1222
Louisiana	Metairie, La.	70003	2914 Wytchwood Dr.	504-885-2349
Maryland	Silver Spring, Md.	20919	8880 Brookville Rd.	301-565-0025
Massachusetts	Somerville, Mass.	02144	52 Holland St.	617-666-4770
	Springfield, Mass.	01103	191 Chestnut St.	413-734-2737
	Detroit, Mich.	48235	13709 W. 8 Mile Rd.	313-862-1783
Michigan	Minneapolis, Minn.	55408	815 W. Lake St.	612-824-2333
Minnesota	St. Louis, Mo.	63130	8456 Page Blvd.	314-428-1299
Missouri	E. Paterson, N. Jersey	07407	158 Market St.	201-791-6380
New Jersey	Buffalo, New York	14212	993 Sycamore St.	716-891-4935
New York	Charlotte, N. Car.	28205	724 Seigle Ave.	704-332-8007
	Cinn., Ohio	45215	8180 Vine St.	513-821-2298
	Columbus, Ohio	43227	4003 E. Livingston Ave.	614-237-3820
Ohio	Parma, Ohio	44134	5682 Cate Rd.	216-845-4480
	Oklahoma City, Ok.	73106	3007 N. May	405-947-2013
	Portland, Oregon	97213	5220 NE Sandy Blvd.	503-282-9636
Oklahoma	Pittsburgh, Pa.	15202	257 Riverview Ave. W.	412-761-7648
Oregon	Upper Darby, Pa.	19082	1742-44 State Rd.	215-352-6609
Pennsylvania	Memphis, Tenn.	38118	3614 Lamar Ave.	901-365-1918
	Houston, Texas	77032	4324-26 Telephone Ave.	713-644-6793
	Longview, Texas	75601	Mopac Rd.	214-753-4334
Tennessee	Norfolk, Va.	23504	3118 E. Princess Anne Rd.	804-625-2030
Texas	Seattle, Wash.	98108	432 Yale Ave.	206-623-2320
Virginia	Milwaukee, Wis.	53215	3509 W. National	414-643-8800
Washington				
Wisconsin				

PTS

IS
NUMBER ONE
AND
STILL
TRYING
HARDER

•

WE OFFER
FINER
FASTER
8 hr.
SERVICE

•

1 YEAR
GUARANTEE

•

NOT A
FRANCHISE
COMPANY

For More Details Circle (6) on Reply Card

New Mallory Ni-Cad Batteries. Rechargeable 1000 times.



Economical recharging —
Mallory BC-1 Charger draws only two watts.

Team these long-life nickel-cadmium cells with an automatic Mallory Charger, and you can recharge them 1000 times, or more.

You'll be sure of having fresh D, C, and AA batteries, while saving money, time and trouble. Mallory Rechargeable Nickel-Cadmium Batteries keep on coming back for more in electronic calculators, tape recorders, radios, cameras, toys, other battery-powered products.

Keep a spare set of Mallory Ni-Cads on hand,

and you'll never run out of battery power again. They recharge to full strength, two or four at a time. And unlike ordinary dry cells that lose voltage during discharge, Mallory Ni-Cads with a full charge maintain operating voltage during the entire work cycle. You get maximum power, continuously, for top product performance.

For the long run, Mallory Rechargeable Ni-Cads . . . the 1000-time batteries. Get them now at your Mallory Distributor.

MALLORY

MALLORY DISTRIBUTOR PRODUCTS COMPANY

a division of P. R. MALLORY & CO. INC.

Box 1284, Indianapolis, Indiana 46206; Telephone: 317-856-3731

Batteries • Capacitors • Controls • Security Products • DURATAPE® • Resistors • Semiconductors • SONALERT® • Switches • Fastening Devices

DURATAPE® and SONALERT® are registered trademarks of P. R. Mallory & Co. Inc.

For More Details Circle (1) on Reply Card

electronicscanner

news of the industry

A proposed rule requiring pre-sale availability of written warranties could cost consumers millions of dollars a year in paperwork, Mayo J. Thompson, a member of the Federal Trade Commission, told **Home Furnishings Daily**. The rule would require retailers to maintain a notebook containing the warranties of every warranted product sold, and require that shoppers be informed of the existence of the notebooks. J. Thomas Rosch, director of the Commission's Bureau of Consumer Protection, said Thompson's cost estimates are "wildly inflated".

Citizens-band license applications for the first five-month period show an increase of 243% over the same period in 1974, reports **Radio & Television Weekly**. Efforts by the Electronics Industries Association and CB manufacturers to persuade the Federal Communications Commission to speed up the process of increasing the number of radio channels available for CB reportedly have had little impact, resulting in a short supply of CB radios. Some manufacturers are said to be reluctant to increase production of radios made with today's standards, because these radios might become obsolete after new channels are opened.

Ray Spence, chief engineer of the Federal Communications Commission, reviewed several actions pending before the FCC, during a CB seminar at the last NEWCOM show. Some possible changes are: a new amateur-radio license, available without a Morse code test, permitting voice operation above 144 MHz; expansion of channels for Class-D CB band; and a new Class-E CB band from 224 MHz to 225 MHz. According to **Radio & Television Weekly**, Spence said it is a challenge to the FCC and the industry to expand CB services in orderly fashion, and end the misuse of CB radio at the same time.

Sales of receiving tubes continue to decline, but the volume remains very important to service dealers. According to an editorial in **Radio & Television Weekly**, the peak was 184 million replacement tubes sold in 1957. Recent sales by years include 96 million in 1973, 81 million in 1974, and in 1975 sales might reach 70 million. This downward trend will continue, as proved by the sales of original-equipment tubes which fell 54% between 1973 and 1974.

According to **Home Furnishings Daily**, **most color TV manufacturers are choosing to offer limited warranties** because of the uncertainties of the full warranty. Most of the confusion is in section 104, which lists certain requirements the warrantor must fulfill in order for the warranty to be designated as a full warranty. Manufacturers say they cannot conform to these requirements because specific rules have not been made.

The Channel Master division of Avnet has given up a 12-year effort to make a success of television sales. An item in **Home Furnishings Daily** said Channel Master had given up sales of console stereos last year, and the new line has only three compact stereo units, compared to 14 last year. Only Broadmoor and Midland now remain as independent television importers.

(Continued on page 6)

TUNER SERVICE CORPORATION

SUBSTITUNER

INTRODUCING
AT JUST

\$44.95
U.S.A. ONLY

WITH CABLES



ONE YEAR
GUARANTEE

STILL ONLY

\$9.95
U.S.A. ONLY

ALL PARTS
INCLUDED

EXCEPT TUBES
AND TRANSISTORS



PROVIDES YOU WITH A COMPLETE SERVICE
FOR ALL YOUR TELEVISION TUNER REQUIREMENTS.

FEATURES

- A UHF Tuner with 70 channels which are detented and indicated just like VHF channels.
- A VHF Hi Gain Solid State Tuner.
- AC Powered
- 90 Day Warranty

Demonstrate the **SUBSTITUNER** to your customers and show improved reception with their TV sets.

You may place your order through any of the Centers listed below.

REPAIR

VHF OR UHF ANY TYPE (U.S.A. ONLY) \$ 9.95
UHF/VHF COMBINATION (U.S.A. ONLY) \$15.00

- IN THIS PRICE ALL PARTS ARE INCLUDED. Tubes, transistors, diodes, and nuvistors are charged extra. This price does not include mutilated tuners.
- Fast, efficient service at our conveniently located Service Centers.
- All tuners are ultrasonically cleaned, repaired, realigned, and air tested.

REPLACE

UNIVERSAL REPLACEMENT TUNER \$12.95 (U.S.A. only)

- This price buys you a complete new tuner built specifically by Sarkes Tarzian Inc. for this purpose.
- All shafts have a maximum length of 10½" which can be cut to 1½".
- Specify heater type parallel and series 450 mA. or 600 mA.

CUSTOMIZE

- Customized tuners are available at a cost of only \$15.95. With trade-in \$13.95. (U.S.A. only)
- Send in your original tuner for comparison purposes to any of the Centers listed below.

HEADQUARTERS	BLOOMINGTON, INDIANA 47401	537 South Walnut Street	Tel. 812-334-0411
ARIZONA	TUCSON, ARIZONA 85713	1528 S. 6th Ave.	Tel. 602-791-9243
CALIFORNIA	NORTH HOLLYWOOD, CALIF. 91601	10654 Magnolia Boulevard	Tel. 213-769-2720
	BURLINGAME, CALIF. 94010	1324 Marsten Road	Tel. 415-347-5728
	MODESTO, CALIF. 95351	123 Phoenix Avenue	Tel. 209-521-8051
FLORIDA	TAMPA, FLORIDA 33606	1505 Cypress Street	Tel. 813-253-0324
	FT. LAUDERDALE, FLORIDA 33315	104 S.W. 23rd St., Bay 16	Tel. 305-524-0914
GEORGIA	ATLANTA, GA. 30310	646 Evans St. S.W.	Tel. 404-758-2232
ILLINOIS	CHAMPAIGN, ILLINOIS 61820	405 East University Street	Tel. 217-358-6400
	CHICAGO, ILLINOIS 60621	737 West 55th Street	Tel. 312-873-6556-7
	SKOKIE, ILLINOIS 60076	5110 West Brown Street	Tel. 312-675-0230
INDIANA	HAMMOND, INDIANA 46323	6833 Grand Avenue	Tel. 219-845-2676
	INDIANAPOLIS, INDIANA 46204	112 West St. Clair Street	Tel. 317-632-3493
IOWA	WEST DES MOINES, IOWA 50265	822 Tenth Street	Tel. 515-277-0155
KENTUCKY	LOUISVILLE, KENTUCKY 40205	2244 Taylorsville Road	Tel. 502-452-1191
LOUISIANA	SHREVEPORT, LOUISIANA 71104	3025 Highland Avenue	Tel. 318-221-3027
MARYLAND	BALTIMORE, MARYLAND 21215	5505 Reisterstown Rd., Box 2624	Tel. 301-358-1186
MASSACHUSETTS	SPRINGFIELD, MASS. 01108	405 Dickinson St.	Tel. 413-788-8206
MISSOURI	ST. LOUIS, MISSOURI 63132	10580 Page Avenue	Tel. 314-429-0633
NEVADA	LAS VEGAS, NEVADA 89102	1412 Western Avenue No. 1	Tel. 702-384-4235
NEW JERSEY	TRENTON, NEW JERSEY 08638	901 North Olden Avenue	Tel. 609-393-0999
	JERSEY CITY, NEW JERSEY 07307	547-49 Tonnetto Ave., Hwy. 1 & 9	Tel. 201-792-3730
N. CAROLINA	GREENSBORO, N.C. 27405	2914 E. Market Street	Tel. 919-273-6276
OHIO	CINCINNATI, OHIO 45216	7450 Vine Street	Tel. 513-821-5080
	CLEVELAND, OHIO 44109	4525 Pearl Road	Tel. 216-741-2314
OREGON	PORTLAND, OREGON 97210	1732 N.W. 25th Avenue	Tel. 503-222-9059
PENNSYLVANIA	PITTSBURGH, PA. 15209	503 ½ Grant Avenue	Tel. 412-821-4004
TENNESSEE	GREENEVILLE, TENNESSEE 37743	1215 Snapps Ferry Road	Tel. 615-639-8451
	MEMPHIS, TENNESSEE 38111	3158 Barron Avenue	Tel. 901-458-2355
TEXAS	DALLAS, TEXAS 75218	11540 Garland Road	Tel. 214-327-8413
VIRGINIA	NORFOLK, VIRGINIA 23513	3295 Santos Street	Tel. 804-855-2518
WISCONSIN	MILWAUKEE, WISCONSIN 53216	4722 W. Fond Du Lac Ave.	Tel. 414-871-7655
CANADA	ST. LAURENT, QUEBEC H4N-2L7	305 Decarie Boulevard	Tel. 514-748-8803
	CALGARY, ALBERTA T2H-0L1	448 42nd Avenue S.E.	Tel. 403-243-0971
		P.O. Box 5823, Stn. "A"	



WATCH US
GROW

IF YOU WANT TO BRANCH OUT INTO THE TV TUNER REPAIR BUSINESS,
WRITE TO THE BLOOMINGTON HEADQUARTERS ABOUT A FRANCHISE.

For More Details Circle (2) on Reply Card

www.americanradiohistory.com

(Continued from page 4)

Appointed by the National Consumer Product Safety Commission to develop TV receiver safety standards by October, 1975, Underwriters Laboratories has set up a technical-advisory group and a consumer product-safety standard committee to work with UL's consumer advisory council to develop and review standards, reports Home Furnishings Daily.

Court action against the New York City Department of Consumer Affairs questioning the legality of the city's authority to license and regulate the TV, radio, and audio repair business, has been dismissed by a New York State Supreme Court judge. In its suit, the Metropolitan Electronic Television Service Dealers Association (METSDA) argued that the regulations would destroy business. According to Home Furnishings Daily, the judge noted that METSDA's objections mainly were against requirements for written estimates for labor and parts on work done in the shop. The judge said the written estimate is the only basis on which the customer can decide whether to repair the item or replace it.

Five broadcast organizations have asked the Federal Communications Commission (FCC) to adopt a plan to improve UHF reception by requiring all new TV sets be built with permanent antennas capable of receiving both bands, reports Home Furnishings Daily. The five broadcast groups said a newly-developed random-access tuner developed by General Instrument could solve the tuning problem by replacing standard rotary dials with a calculator-like push-button control which automatically tunes the set.

Henri G. Busignies, chief scientist emeritus of International Telephone and Telegraph Corporation, has been awarded the Armstrong Medal, the highest honor of the Radio Club of America. The medal, named after Major E. H. Armstrong, electronic scientist and inventor of FM radio, is given to an individual judged by the Radio Club to have given outstanding service to the radio-electronics industry.

A 10-man delegation representing the Electronic Industries Association's communications manufacturers, visited the People's Republic of China last month to tour Chinese telecommunications facilities and production centers and present a "communications applications" seminar. China National Machinery Import & Export Corporation issued the invitation, which is the first time a trade delegation from a single U.S. industry has been asked to visit China.

Mobilfone Radio System supplied personal radio pagers to city lifeguard chiefs in a summer-long experiment in advanced beach and water safety communications at Rockaway Beach, New York. Ten chiefs, who supervise 250 lifeguards stationed along the 7½-mile beach, were outfitted with tone and voice pagers for immediate notification of emergency situations. □

Satisfy frequency measurement requirements in Citizens Band Radios



B&K PRECISION MODEL 1801 \$230

With autoranging 20Hz to 40MHz guaranteed and typical upper limit of 60MHz you can precisely measure the frequency of Citizens' Band transmitters and many other low band radio services. Model 1801's typical accuracy of better than 10PPM is always available for every measurement because there are three decimal point positions automatically selected by the frequency of the signal you are measuring. And you can suppress the first digit for still more resolution above 1MHz by moving the mode switch from Auto to 1 second. This six-digit counter gives you 1Hz resolution!

Discrete, reliable TTL circuitry automatically updates the large, bright readout up to five times per second—which means the 1801 works faster than you can. There's almost no way to make a reading error because Hz or MHz and Overrange are shown by discrete, separate LED's.

If you want to make receiver tests and don't have a signal generator with the required precision, you can measure the output of your generator* with the 1801 and adjust it to the accuracy you need!

* 30mV or more

If you aren't making measurements as accurately and easily as these, you need a B&K-Precision Model 1801 which is in stock at your electronic distributor. Write for detailed specifications.



MHz display of CB channel in AUTO mode.



KHz display of same CB channel showing suppression of leading digits.

B&K PRECISION
PRODUCTS OF DYNASCAN
 1801 W. Belle Plaine Avenue
 Chicago, IL 60613

Chassis—RCA CTC58
PHOTOFACT—1365-1

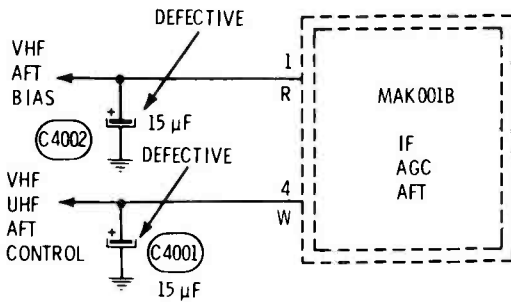

Symptom—With AFT on, has herringbone in picture
Cure—Check C4001 and C4002 AFT capacitors, and replace if open

Chassis—RCA CTC58
PHOTOFACT—1365-1

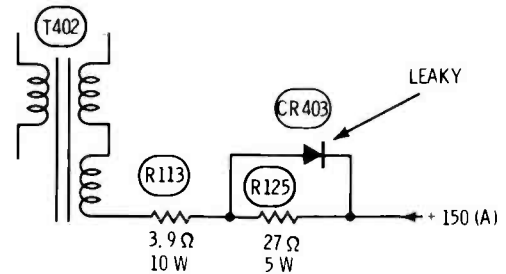

Symptom—Black vertical line, located several inches from left edge of picture
Cure—Check CR403, and replace if leaky or defective

Chassis—RCA CTC58
PHOTOFACT—1365-1

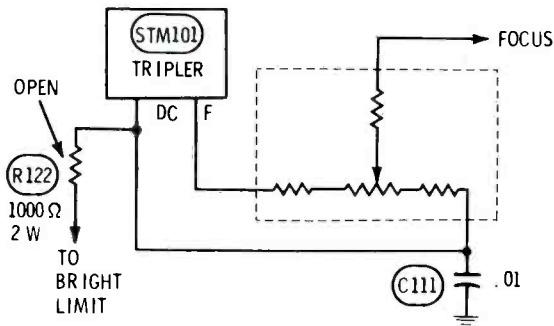

Symptom—Intermittent arcing, blooming, or flashing of picture
Cure—Check R122, and replace if open

Chassis—RCA CTC46
PHOTOFACT—1278-3

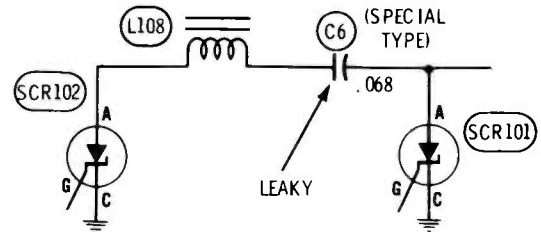

Symptom—Critical horizontal locking, trips breaker when off frequency
Cure—Check C6, and replace if leaky

Chassis—RCA CTC48
PHOTOFACT—1300-2

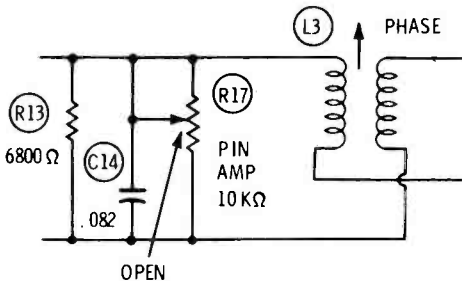

Symptom—Decreased height, slight trapezoid
Cure—Check R17, and replace if open

Chassis—RCA CTC48
PHOTOFACT—1300-2

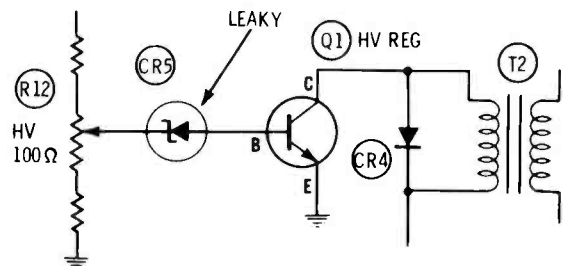

Symptom—Decreased HV
Cure—Check CR5 zener diode, and replace if leaky

reader's exchange

Needed: Manufacturer's address, or address of anyone providing parts, for Wilkinson line locator, Model WH-4.

B. G. Dean
Box 293
Dyersburg, Tennessee 38024

Needed: Schematic or manual for Laboratory For Electronic oscilloscope, Model 401. State your price.

Hoy D. Brannon
3909 Moller Road
Indianapolis, Indiana 46254

Needed: Transistor for a General Electric digital clock radio, Model C4315A. Numbers on transistor are 7672 and 7223.

J. Mehalko
324 Fourth Street
Blakely Olyphant, Pennsylvania 18447

Needed: Schematics for Blaupunkt "Ballett" AM/FM radio, Model 2500USA and "Candle" miniature TV, Model MT510A.

William Bernstein
215 Middleneck Road,
Building 7
Great Neck, New York 11021

Needed: Deflection board, part number X-40043-49-1 for Sony TV, Model 4-203UW. State condition and price.

Morton's TV
510 C
Cache, Oklahoma 73527

Needed: Picture tube number 280-GB4 for Sears TV Model 6104; one good HV transformer for Model GR-53A, series 506-6638 Heath color TV; also schematic and alignment data for an RCA 9K29 chassis.

Sherwood T. Smith
RR #4, Mile Hill Road
Rockville, Connecticut 06066

For Sale: Eico Model 460 oscilloscope with probes; Eico dynamic tube and transistor checker, Model 667; and Sencore color generator, Model CG141. Excellent condition. Will accept best offer.

Jim Staker
8102 East Windsor Avenue
Scottsdale, Arizona 85257

GET SOMETHING EXTRA from CHEMTRONICS



FREE!
POPULAR 2 SIDED PROFESSIONAL
ALIGNMENT TOOL WITH THESE
CHEMTRONICS
PRODUCTS



AVAILABLE
FROM YOUR PARTICIPATING
**CHEMTRONICS
DISTRIBUTOR**

DON'T GET STUCK WITH THE TAB.

**Do your Christmas shopping before
midnight Nov. 30th.**

If you've been saving Sylvania tube tabs, your time has come.

Unless your tabs are received at award headquarters by midnight Nov. 30th, all you'll have is a bunch of tabs.

And that includes those color picture tube labels that are worth 20 receiving-tube tabs.

But before that magic hour you can have anything in the '75 Save-a-Tab catalog.

After midnight your tabs will be as valuable as Cinderella's pumpkin.

Do your Christmas shopping now for everyone (especially yourself) from the catalog available at your Sylvania distributor.

But have your tabs at award headquarters by midnight Nov. 30th.

Nov. 30th, the world.

Dec. 1st, just tabs.

GTE SYLVANIA



FAST

COMPLETE SERVICE ON ALL MAKES OF TV TUNERS

Maximum Time In Shop 24 Hrs.

(Warranty: One Full Year)
 (WE SHIP C.O.D.)
 YOU PAY SHIPPING
\$9.95

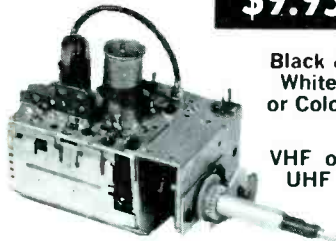

Black & White or Color

VHF or UHF

UV Combo's \$16.50

Price includes all labor and parts except Tubes, Diodes & Transistors. If combo tuner needs only one unit repaired, disassemble and ship only defective unit. Otherwise there will be a charge for a combo tuner. When sending tuners for repair, remove mounting brackets, knobs, indicator dials, remote fine tuning arrangements and remote control drive units.

WE UNCONDITIONALLY GUARANTEE All Tuners FOR ONE FULL YEAR



All tuners are serviced by EXPERTLY TRAINED TECHNICIANS with years of experience in this specialized field. All tuners are ALIGNED TO MANUFACTURER'S SPECIFICATION on crystal controlled equipment and air checked on monitor before shipping to assure that tuner is operating properly.

GEM CITY TUNER SERVICE

Box 6G Dabel Station
 1621 Mardon Drive
 Dayton, Ohio 45420

troubleshootingtips

Send in your helpful tips—we pay!

Intermittent sound, then no sound Teledyne Packard Bell 98C32 (Photofact 1374-2)

By the time I received the TV, there was no sound and no collector voltage at the audio-output transistor. Previously, the sound had been intermittent, according to the customer.

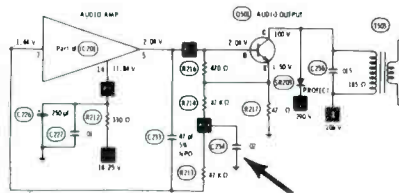

These symptoms seemed to indicate a defective IC or output transistor; however, replacement didn't help. After considerable testing, I found C234 had leakage (about 100K). Replacement with a new capacitor brought back the sound.

Burton Bicksler, CET
 Geneva, New York

Failure of output transistor Hitachi Model CWA200 (Photofact 1129-1)

This repair illustrates an important and basic problem of testing transistor circuits: how do you keep a transistor from destroying itself, while you test for an overload?

The Hitachi color receiver had neither sound nor picture. But much difficulty I found an open 1-ampere fuse in the regulated power supply. Also, a shorted horizontal-output transistor had blown the fuse.

Now, the DC voltage for the audio comes from scan-rectification of horizontal pulses, so after I had replaced the fuse and output transistor the sound started working. Unfortunately, there was no raster or high voltage, and soon the sound stopped when the fuse blew again. You guessed it. The new horizontal-output transistor was shorted.

How could I make more tests

without destroying another \$12 transistor? Ohmmeter tests were inconclusive, but showed no serious short. Finally, I decided to limit the transistor current by installing an emitter resistor. After trying several resistors, I found a value of .68 ohms at 5 watts to be a good compromise.

The transistor didn't fail and the sound was okay, but there was little AC high voltage or boost voltage. When I disconnected the solid-state high-voltage rectifier unit, a neon bulb indicated normal AC voltage. All the horizontal waveforms then were normal. Re-connecting the rectifier reduced the B-boost and AC HV; it seemed certain the HV rectifier was at fault, and a new one did repair the set.

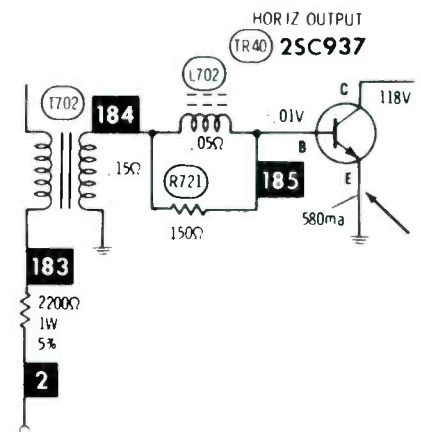

However, in this receiver, the HV rectifier is a part of the flyback, so replacement of the various deflection components would have been very expensive. In addition, it's likely several more output transistors would have been ruined during the tests. That's why I recommend the temporary addition of an emitter resistor as a method of buying time for tests, without extra transistor failures.

Forrest C. Kleinsorge
 Maplewood, Missouri

Your comments and ideas are welcome.

Introducing... the Money Generator

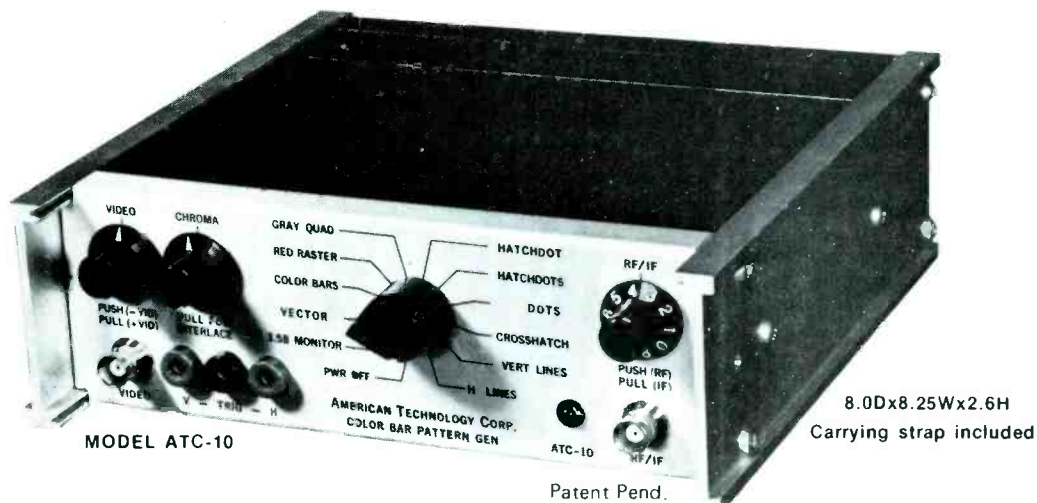

A Better Approach to TV Analyzing

ATC-10's Unique Patterns

UNIFORM

RED
RASTER

RED RASTER

Check and adjust purity at the flip of a switch without disabling blue and green electron guns.

BANDS OF
FREE RUNNING
COLORS

3.58 MONITOR

Check and adjust color Sync. OSC. Freq. at the flip of a switch (No need to ground AFPC Test Point.)

COLOR BARS

Sixth bar marked for identification.

Luminance pedestal shows color fit.

GRAY QUAD

Gray scale tracking checks/adjustments.

Yoke orientation.

L.F. video response.

HATCHDOT

Composite convergence patterns enable you to complete an entire convergence series with no need to alternately select separate patterns for DC and dynamic convergence.

HATCHDOTS

The hatchdots pattern with its frame-of-dots is also great for size, linearity, centering, and pincushion checks and/or adjustments.

Great Money Generating Features

The ATC-10 combines a variety of new money-generating features for faster in-home servicing with the most commonly used signal injection features of the B & K Analyst. Some additional features are:

- CRYSTAL CONTROL AND PHASE LOCK OF ALL CHROMA AND SWEEP FREQUENCIES PROVIDE PATTERNS WITH UNMATCHED CLARITY AND FREEDOM FROM INTERFERENCE — CHROMA WAVEFORMS ARE VIEWED AS STATIONARY SINE WAVES USING H TRIGGER.
- IN-HOME BANDPASS CHECKS AT 1.78 MHz AND 3.56 MHz.
- ALL CRYSTAL-CONTROL / SOLID-STATE / DIGITAL IC DESIGN PROVIDES MAXIMUM RELIABILITY AND COMPLETE FREEDOM FROM VERTICAL LINE WIDTH AND COUNTER STABILITY ADJUSTMENTS.
- EXTRA WIDE RANGE RF/IF OUTPUT ATTENUATOR TESTS RECEIVER SENSITIVITY AND DYNAMIC RANGE.
- IF AND VIDEO INJECTION OUTPUTS WITH "FUSELESS" PROTECTIVE CIRCUITS.
- INTERLACE SELECTABLE FOR H/V COUNTDOWN TV'S.
- SQUARE WAVE PROVIDED FOR VIDEO PEAKING TEST.
- HORIZ. AND VERT. TRIGGER OUTPUTS OPTIMIZED FOR EXPANDED OSCILLOSCOPE PRESENTATIONS.
- 2 YEAR FACTORY WARRANTY AGAINST DEFECTIVE WORKMANSHIP AND MATERIALS.
- 30 DAY MONEY BACK GUARANTEE.

American Technology Corporation

225 MAIN, DEPT. 9A, CANON CITY, COLORADO 81212

- Please send additional information on the MOD. ATC-10.
- Include a copy of the 2-volume (Home/Shop) ATC-10 Owner's Manual. \$1.00 enclosed to cover postage and handling.
- Please ship _____ Model ATC-10's at \$299.95 with:
 - Chan. 2 RF CRYSTAL (std.) installed (NO Chan. 2 transmitter in our area.)
 - Chan. 3 (optional) crystal installed. (Chan. 2 transmitter in our area.)

Subtotal _____

3% sales tax (Colorado residents only) _____

TOTAL REMITTANCE ENCLOSED _____

Send certified check or M.O. for fastest shipment to American Technology Corp., 225 Main, Dept. 9A, Canon City, CO 81212

Name of Individual or Firm _____

Address _____

City _____ State _____ Zip _____

SERVICING STEREO AUDIO SYSTEMS

Part 1



By J. A. "Sam" Wilson, CET

This series will explain the technical aspects of Hi-Fi stereo audio systems. The information should enable you to successfully repair almost any audio defect, as well as prepare you to pass the audio CET test. Sam is a co-author of the popular Howard W. Sams book "Study Guide For CET Examinations". Part 1 is an overview of the various signal sources and sections of a complete stereo system. Analysis of the electronic circuitry will be presented later in the series.



Dawn Pointer demonstrates a Zenith stereo system.

As the number of TV repairs continues to dwindle, many authorities are urging TV technicians to diversify by branching out into the repairing of other kinds of equipment. One natural move is into the audio field, including such machines as console stereos, modular or component systems, and portable record players. Just refuse to work on the "cheapies", and you'll find the business quite profitable.

Much of the test equipment you now use for TV servicing will be suitable for audio work. Meters and a scope are universal. Later, you should add such equipment as a distortion meter, audio generator,

and FM-alignment gear. However, you can add those as you gain skill and income.

Different Customers

One difference between TV servicing and audio servicing is in the type of customer you are likely to encounter. Although you occasionally might run across a man with a \$1500 stereo system who thinks a microbar is a saloon for midgets, many audio customers are quite knowledgeable about stereo equipment. Perhaps they have read many books and magazines, or received some technical training. That kind of customer will have more con-

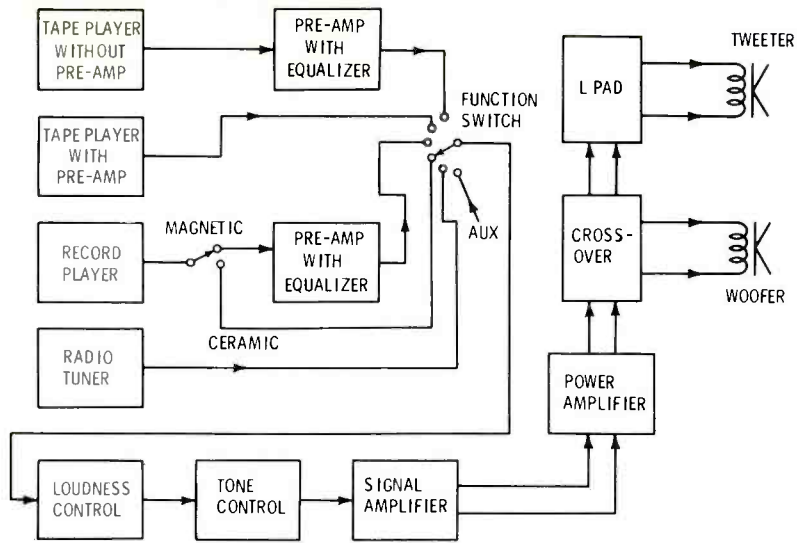
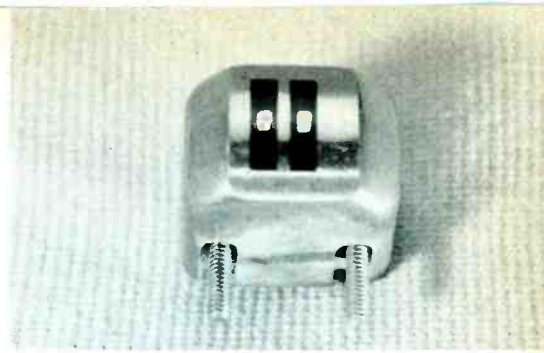
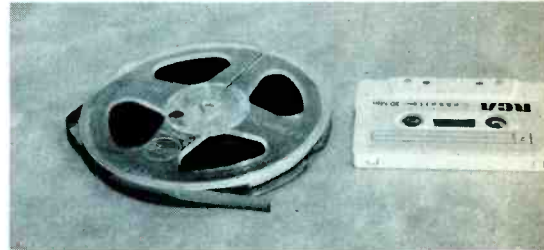

Fig. 1 Many modern stereo systems conform to this block diagram. The tape players, record changer, and radio must have two outputs for stereo; also two identical amplifiers and speakers are required.



This tape head is for four tracks on 1/4-inch tape.



A 5" reel with 1/4-inch tape is at the left, and at the right is a cassette which uses 1/8-inch tape.

confidence in you if you speak "audio" language and know the field. It's unusual for a TV customer to talk circuitry or accurately describe symptoms.

Complete Stereo Systems

Stereo systems are available in a multitude of shapes, sizes, and specifications. Figure 1 shows the block diagram of a typical system. The various sections might be assembled into one unit, or each could be physically separate, with wiring connecting them. Only one channel is shown; the second channel would be the same electronically.

Equalizing Circuits

Notice, as we discuss in turn the various signal sources for stereo listening, how often some kind of equalization is used. Equalization consists of increasing or decreasing the amplitude of certain bands of audio frequencies by the use of resistance/capacitance or inductance/capacitance filters. Some typical circuits will be discussed later.

During tape recording, for example, it's customary for the head to be supplied with "constant-cur-

rent" audio signals. That is, the head current is the same for a bass (low-frequency) tone as it is for the same amplitude of a treble (high-frequency) note. Without equalization, the head, during playback, would have a severe loss of low frequencies. Therefore, a large amount of bass boost is employed during playback.

Even that is not enough to give flat response, because several factors (including the tape speed versus the gap width of the head) roll off the high frequencies. High-frequency boost during playback would tend to degrade the signal-to-noise ratio by amplifying tape hiss, so most machines boost the treble during recording, and boost the bass during playback. Generally, this is true of pre-recorded tapes as well.

Magnetic phono cartridges also require large amounts of equalization. Generally, the individual input sources of stereo audio are equalized (if necessary) for "flat" response. Then the main amplifier is designed to be flat, except for tone controls and loudness controls. Equalization of individual inputs is necessary, while tone and loudness controls are not required, but often are very desirable.

Tape Players

Three basic types of tape players are in general usage: cassette; eight-track (Stereo-8); and reel-to-reel (open reel). Each type has advantages and limitations. None are compatible; that is, a cassette tape can't be played on a Stereo-8 machine, etc.

All tape heads have extremely-weak output, and poor low-frequency response. Both amplification and equalization take place in the preamplifier. The gain should be sufficient to produce an output level approximately the same as that of other signal sources, such as radio and phonograph.

Record Players

Records can be played on inexpensive record-changer units, or on elaborate turntable-and-arm assemblies costing several hundred dollars. We'll not comment on this aspect now, but instead take up a more universal area: the phonograph cartridge, and how to obtain the best results from each type.

Piezoelectric elements

Rochelle-salt and ceramic are two kinds of crystal materials that give off a voltage when they are subjected to mechanical stress. As

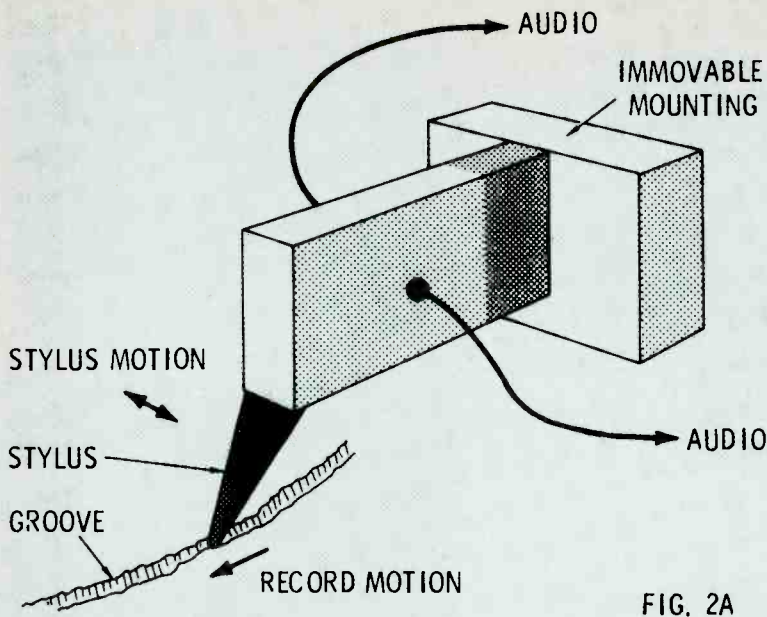

FIG. 2A

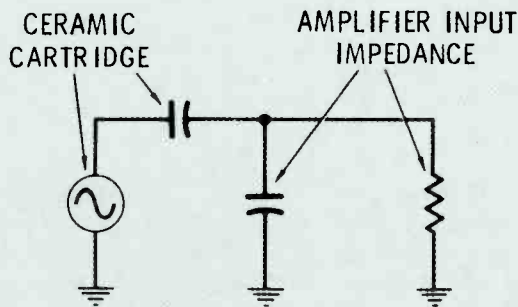

FIG. 2B

Fig. 2 Undulations of the record groove move the stylus, which twists the ceramic element, causing a signal voltage at the output. Stereo cartridges have two elements, one tilted 45° to the right, and the other tilted 45° to the left, and both are driven by a single stylus. A ceramic cartridge operates as though it is a source of audio signal in series with a capacitor. Therefore, a loss of bass will result from an amplifier resistance that's too low. Output voltage is higher than that of other types.

shown in Figure 2, a stylus (formerly called a "needle") is attached to a chunk of crystal so the side-ward movement when tracking the undulations of the record groove twists the crystal while the other end is fastened solidly to the case of the cartridge. Strips of metallic foil, which are attached to two faces of the crystal slab, bring the voltage out to terminals for transfer to the amplifier.

Although it was easier to achieve good bass response with Rochelle-salts, those types now are obsolete because they were susceptible to

physical damage, and often were ruined by heat. Ceramic types have replaced them.

Ceramic frequency response

Basically, ceramic cartridges have "constant amplitude" frequency response. A certain movement of the stylus produces the same voltage regardless of whether the frequency is low or high. That sounds ideal, as though no compensation or equalizing would be required for flat response.

There's a large measure of truth in that last statement. But it

ignores the frequency response of disc recordings. All recordings of disc masters are made by magnetic recording heads, which give "constant velocity" response. Also, to complicate the situation, low-frequency attenuation and high-frequency boost both are used during the recording of discs. This provides approximate (but not exact) constant-amplitude response. Therefore, stereo systems of less than ultimate quality often use ceramic cartridges without any equalization.

When an engineer designs a ceramic cartridge, one difficulty is in minimizing undesired resonant points of the frequency response. Another is in making the stylus move easily to provide good tracking on loud passages, but without reducing the output voltage too much. Slabs of ceramic material are hard to twist.

It is difficult to connect an amplifier and a ceramic cartridge without some reduction of bass tones (low frequencies). Imagine a ceramic element as being a generator of constant-amplitude audio frequencies (same output at all frequencies for equal groove deviation), but also with the output signal coupled to the amplifier through a small capacitance (Figure 2B). Of course, such a circuit is an RC high-pass filter; and the smaller the value of the input resistance of the amplifier, the more the bass is attenuated.

The stray capacitance of shielded connecting cable and wiring is less of a problem, because it and the apparent capacitance of the ceramic cartridge form a capacitive voltage divider, which merely reduces the amplitude, without changing or degrading the frequency response.

In fact, in cases where it's difficult to obtain 1 megohm or higher for good bass, a capacitor connected across the output signal of the cartridge reduces the amplitude, but improves the bass response.

Magnetic frequency response

The characteristics of magnetic-type phono cartridges are almost complete opposites of those for ceramics.

Magnetic cartridges operate under a principle called "Faraday's Law", which says that a conductor

Tear 'n Share

Save your RCA entertainment receiving tube carton ends* and color picture tube warranty serial number stickers* . . . and redeem them for discount certificates or valuable premiums. Just tear and you'll share!



*Save the receiving tube carton end that is solid red reading RCA Electronic Components and the warranty serial number sticker that appears above the warranty envelope on the upper right hand corner of the RCA color picture tube carton. *One* color picture tube warranty serial number sticker is equal in value to *20* receiving tube carton ends.

Your RCA receiving tube carton ends are valuable! So are your RCA color picture tube warranty serial number stickers. Save them. In various quantities, they will bring you:

- Discount certificates. You can apply these toward purchases of more RCA receiving tubes and color picture tubes from your RCA Distributor.
- Popular merchandise premiums. You can choose from a wide selection for yourself, your family, or your home.

Here's how you do it. See your participating RCA Distributor. Pick up your copy of the RCA "Tear 'n Share" Prize Book and saver envelope. Mail the required number of RCA receiving tube carton ends or RCA color picture tube warranty serial number stickers in the envelope provided, specifying discount certificates or the premium you've selected to:

RCA Tear 'n Share Headquarters,
P.O. Box 154, Dayton, Ohio 45401.



RCA

Distributor and Special Products Division, Cherry Hill Offices, Camden, N.J. 08101

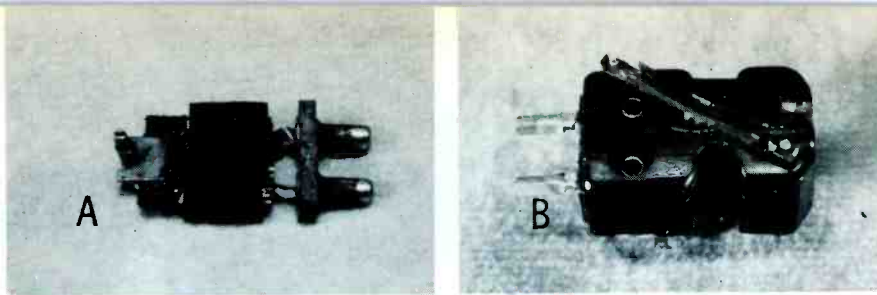

Picture (A) shows the inside of an old monaural crystal or ceramic phono cartridge. The stylus is supposed to be held in the groove of the rod at the left. An obsolete General Electric "variable reluctance" magnetic cartridge is pictured in (B). The dual-stylus assembly has been turned partially around to expose the two small pole pieces on the right. In this cartridge, the stylus moving between the pole pieces furnished the change of inductance.

moved through a magnetic field, or a magnetic field moved across a conductor, causes a voltage to be generated in the coil. Although there are many variations, magnetic cartridges usually are "moving-magnet" or "moving-coil" types, as shown in Figure 3. Sometimes the moving-magnet is called a magnetic type, and the moving-coil is designated as a dynamic type.

According to Faraday's Law, the amount of voltage generated in a magnetic or dynamic cartridge depends on the number of turns in the coil, the strength of the mag-

netic field, and rate or speed at which the relationship of coil and field are changed.

In a practical cartridge, the number of turns of the coil and the strength of the magnetic field are not variable. But the amount of movement and the speed of that movement both affect the output voltage. Of course, it's understood that louder volume on the record (more groove modulation) produces an increased output voltage. But the speed or rate of change also affects the output amplitude; in other words, **the output is not flat**

according to frequency.

Magnetic cartridges are said to be "velocity modulated". Both constant-velocity and constant-amplitude responses are illustrated by actual swept-audio waveforms in Figure 4.

Constant-amplitude (Figure 4A) operation means that a constant amplitude of signal voltage will produce the same sideways deviation of the stylus of a crystal-type recording head. Look at the waveform and imagine it is a section of groove on a record. When played back by a crystal (ceramic) cartridge, the output should be essentially the same for all frequencies (waveform A, as viewed on a scope).

By comparison, a magnetic recording head driven by a constant-voltage signal (Figure 4A) records a stylus motion that is constant-velocity (Figure 4B). That is, the total distance traveled sideways by the tip of the magnetic recording stylus is the same per time period for both low and high frequencies. When the frequency is high, the inductance of the head opposes the flow of current; therefore, the current (stylus movement, too) is less as the frequency is increased. Incidentally, this large increase of stylus motion at the low frequencies is why bass rolloff is used during recording; it prevents cutting into an adjacent groove.

If constant voltage for all frequencies were fed to a magnetic recording head, and the signal played back with a magnetic cartridge, the frequency response would be flat. In practice, this is never



You can determine the frequency response of test discs (which have been recorded with different-frequency sine waves) by holding the record so the light from a point-source lamp (a small bare bulb will do) is reflected from the grooves and into your eyes. This is not a test record, but if it were, the width of the light pattern would indicate the relative amplitude of each band of audio tones.

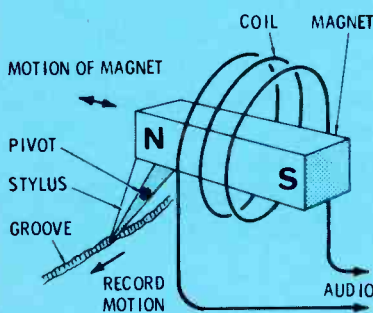

FIG. 3A

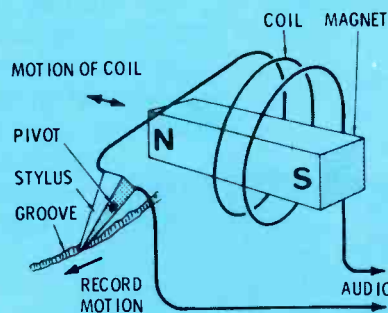

FIG. 3B

Fig. 3 Magnetic phono cartridges are available in two main types. (A) In moving-magnet cartridges, the magnet moves inside the coil, causing a voltage. (B) Dynamic cartridges move the coil around a fixed magnet. As shown in (C), a magnetic cartridge acts as if it were a constant-voltage source in series with an inductance. Paralleling capacitances can cause undesired resonant points, while resistance loads that are too low in value can reduce the high-frequency response. Output voltage is very low.

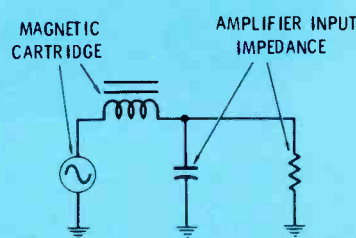

FIG. 3C

done, because the signal-to-noise ratio would be very poor. Instead, the response curves of both recording and playback are equalized to give **overall** flat response with minimal noise.

A recording that's made constant-amplitude (Figure 4A), and played by a magnetic cartridge and an unequalized preamp, would produce a playback response as shown in Figure 4C, a loss of bass frequencies.

Now, most recording curves are approximately constant-amplitude after treble-boosting and bass-rolloff with a magnetic recording head. Therefore, to achieve flat response when a magnetic playback cartridge is used, it's necessary to incorporate a large-amount of bass boost in the preamp.

Effects of load impedance

Capacitance and resistance of a preamp input (load on a magnetic cartridge) affects the frequency response differently than those in circuits for ceramic cartridges.

A magnetic cartridge acts as a constant-amplitude generator that's in series with a coil having an inductance equal to the cartridge (Figure 3C). Most cartridges achieve optimum results with a load impedance of 47K ohms. The coil inductance and the input resistance form an RL low-pass filter. So, the lower the load resistance, the greater is the loss of high frequencies. Sometimes, a reduced resistance is chosen deliberately to minimize excessive treble response, or to reduce the level of any resonant peaks.

Total capacitance of shielded cable and amplifier input wiring can form a tuned circuit with the inductance of the magnetic cartridge. The resonant peaks that result might be either good or bad, depending on the frequency. Some cartridges depend on this resonance to extend the high-end response. But, if the peak is too low in frequency (excessive capacitance), ringing can develop, causing an unpleasing tone quality.

To insure satisfactory frequency response, many manufacturers of cartridges specify a range of load resistance and capacitance for each model.

Preamps for magnetic cartridges usually have a large amount of bass boost and some treble rolloff. And, because the record manufacturers don't always follow a standard response, many preamps have switches to select different bass and treble curves.

Pickup summary

Ceramic phono cartridges have a comparatively-high output voltage (perhaps .1 to .5 volts AC) and need an input resistance higher than approximately 1 megohm to prevent loss of bass frequencies. Output of the cartridge often goes direct to the volume or loudness control.

Magnetic cartridges have low output voltages (perhaps 5 to 10 millivolts). Therefore, a preamp is required to increase the level. Also, the preamp provides the proper load resistance, and includes bass boost and treble rolloff to produce reasonably flat response.

Tuner And Auxiliary Inputs

AM/FM/FM-multiplex tuners are most often found in stereo audio systems. These tuners actually are radio receivers that are complete except for audio amplifiers. Other than some multiplex traps and the usual FM 75-microsecond treble rolloff, which merely restores the flat response, no equalizing is incorporated in the tuner.

The AUX input shown in Figure 1 can be used for television sound, or for another type of tape player.

Also, some systems have an input for microphones. Mikes require almost as much preamplification as do magnetic cartridges. But, other than some attention to the optimum load impedance, microphones need flat amplification. The magnetic-cartridge preamp can be used, if there is a way provided to disconnect the equalizer components.

Loudness Controls

Circuits of the volume controls in stereo systems often are more complicated than the ones in TV's or simple radios. There is a good reason for such extra circuits.

Loudness Controls change the frequency response as they also change the volume. Now, this is not because of any lack of flat response in the amplifier. And all the input signals have been equalized for flat responses before they reach the loudness control.

No, the need for frequency compensation according to volume level originates in an important characteristic of human **ears**. In short, our ears provide flat response

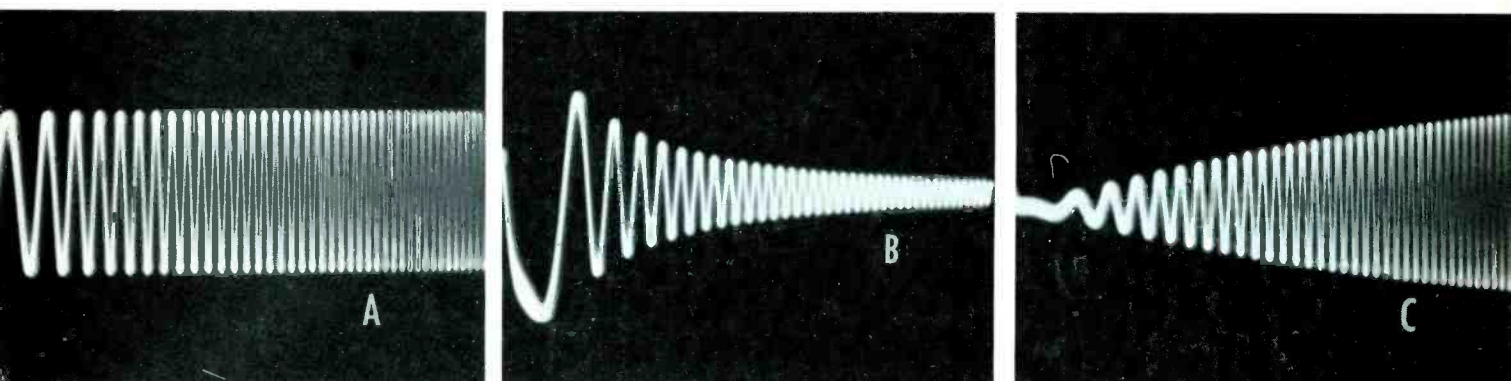

Fig. 4 (A) The waveform is an audio tone swept from a low frequency at the left to a higher frequency at the right. This is "constant-amplitude" response, in which the amplitude is the same for all frequencies. (B) "Constant-velocity" response increases the amplitude at low frequencies. (C) The decrease of low frequencies shown here could be caused by playing a constant-amplitude recording with an unequalized magnetic cartridge. Note: these waveforms were produced by sweeping the audio-frequency sine waves of a Tektronix FG502 function generator by the sawtooth output of a Hickok function generator.

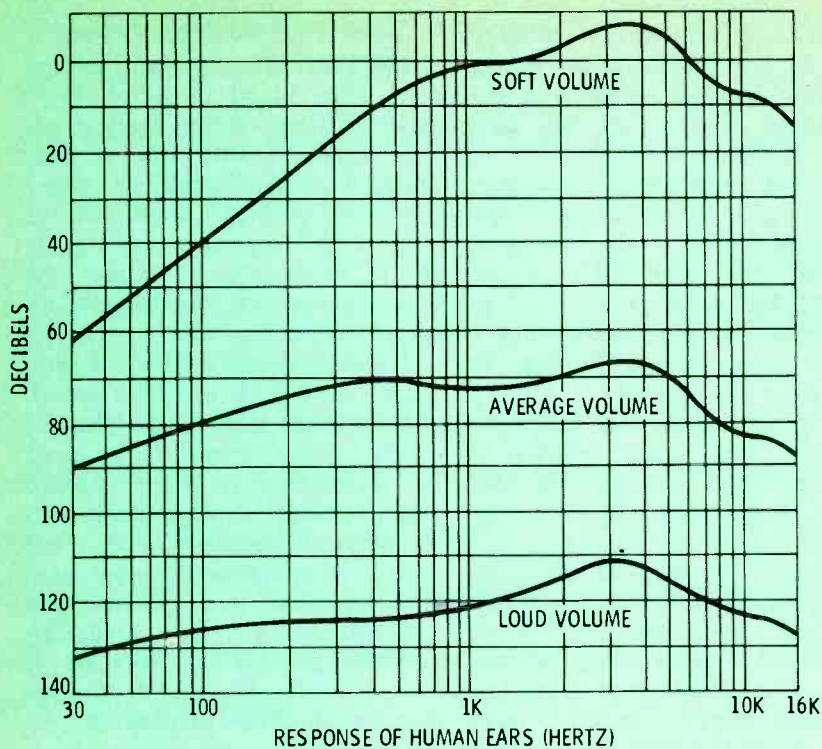

FIG. 5A

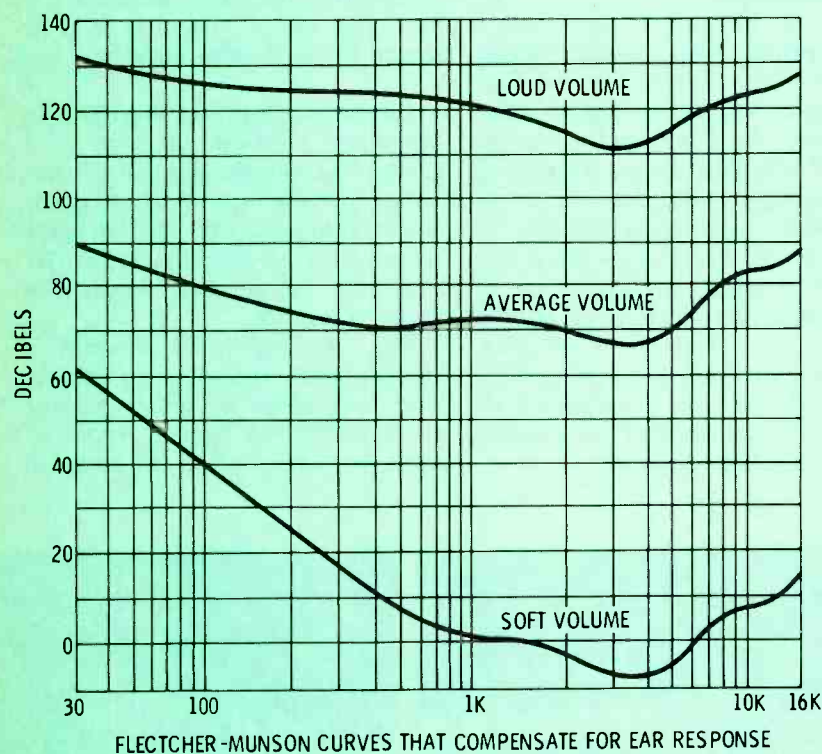

FIG. 5B

Fig. 5 The frequency response of human ears changes with the volume level of sounds, as shown by graph (A). Equalization of an amplifier which would make the response sound flat to the ear at those levels is shown in graph (B). Loudness controls attempt to correct for this ear characteristic by increasing the relative amplitude of bass and treble as the volume is decreased.

to all audio frequencies only when the sound level is very loud, almost at the point of producing pain. Figure 5 shows three examples of ear response, and the Fletcher-Munson curves necessary to restore flat frequency response at those sound levels.

For example, music played at very-soft volume requires about 60 decibels of bass boost at 30 Hz and about 15 dB boost at 16 KHz to restore the **apparent** balance of lows and highs. It's likely that none of the actual loudness-control circuits supply so much compensation; but even partial restoration of frequency balance is better than none.

A typical loudness-control circuit (Figure 6) is built around an audio pot that has two fixed taps on the element. C1 and C2 provide some high-frequency boost, while C3/R1 and C4/R2 increase the bass response.

To be perfectly accurate, the highs and lows are **not** boosted, instead the middle frequencies are **attenuated** more than the lows and highs.

Here's how it works: at extreme low frequencies (perhaps 100 Hz or lower) the reactances of C3 and C4 are so high that the amount of signal is determined solely by the setting of the loudness control, R3. At middle frequencies C3 and C4 are nearly short circuits, and the output is less because R1 and R2 reduce the resistance of the bottom leg of the control, which acts as a voltage divider. Therefore, the amount of gain at mid frequencies depends on the values of R1 and R2 relative to the setting of the control.

At high audio frequencies, C1 and C2 parallel the top leg of the loudness control, thus increasing the amplitude of the treble.

To sum up the action, when the sliding tap of R3 is at the top tap, R1 and C3 are providing about 5 dB per octave of boost below about 500 Hz. This amounts to about 12 to 14 dB boost at 30 Hz. C1 also gives some treble boost. But when the sliding tap is at the bottom tap, both compensation networks are effective, and the maximum bass boost approaches 24 to 28 dB at 30 Hz. C1 and C2 both increase the treble response.

At the other extreme, when the control is turned full on, neither boosting network has any effect, so

the response is flat.

For the most realistic results, a conventional volume or gain control should be included in addition to the loudness control. With the loudness control at maximum, the gain control should be adjusted for extremely-loud volume. After that the gain control should not be touched, but the volume adjusted by use of the loudness control.

If loudness control circuits and adjustments were perfect, any change of volume would still maintain the same balance between, middle, and high frequencies.

Does that sound like cheating? Well, maybe so. Some audio purists believe that symphony orchestra music should be reproduced at the same volume as in the recording studio or music hall. In such cases, a loudness control is not needed. But many people prefer their music played at moderate volume, or they live in an apartment where loud sounds might get them evicted.

Tone Controls

Treble and bass tone controls can be adjusted to increase or decrease the high frequencies and low frequencies as the listener desires. Although the "Golden Ear" listeners maintain tone controls should not be needed, there are several occasions when they are desirable. Amplifiers and most of the signal sources (radio, phone, etc.) can be built to be almost perfectly flat in response. Not so with speakers. Also, room acoustics greatly affect the way music sounds, and loudness controls don't always correct enough.

Therefore, the ability to equalize the lows or highs to make the music more pleasant, or more realistic, is an important one.

Amplifier And Speaker

Briefly stated, the main amplifier should have sufficient gain to supply the volume you want, and enough power to keep that volume undistorted.

Speaker systems can be inefficient, highly efficient, or only moderate in efficiency. More audible volume is produced from the same amplifier power by efficient speaker systems, and this must be taken into consideration when a customer selects both the amplifier and the speaker.

The frequency band between 32 Hz and 16 KHz is about 9 octaves, and it is very difficult to build a single speaker capable of reproducing this range with good fidelity. That's why so many Hi-Fi speakers incorporate two or more specialized individual speakers. Low-frequency speakers often are called "woofers" and high-frequency speakers are termed "tweeters".

Although a woofer and a tweeter could just be wired in parallel, that's not the way to obtain the best results. Tweeters might bottom-out and rattle from bass notes; and the tone quality is better when each is supplied only with the frequencies they can reproduce most efficiently.

Separating the signal into high-frequency and low-frequency signals is the job of "dividers". A divider network can be as simple as a couple of back-to-back electrolytic capacitors in series with the tweeter, or it might contain two precision inductances and two oil-filled capacitors per speaker.

One additional problem remains:

woofers and tweeters usually are not matched in efficiency, especially if the tweeter is a horn type that has about ten times the output of a cone type. The answer is to use some kind of passive loss device. A simple pot has several drawbacks, which are solved by a special control called an "L" pad (Figure 7).

Summary

Of course, stereo equipment demands two of most everything. A stereo phono cartridge is just one component, but it has two separate output signals. Two loudness controls are required, although they can be on the same shaft. Two sets of tone controls and amplifiers are necessary, even when both are on the same chassis. And two speakers systems complete the stereo setup.

This month, most of the information has been general, and about stereo as a system. However, you now should know why a ceramic phono cartridge should not be substituted for a magnetic, and vice versa. Next part begins coverage of more specific areas. □

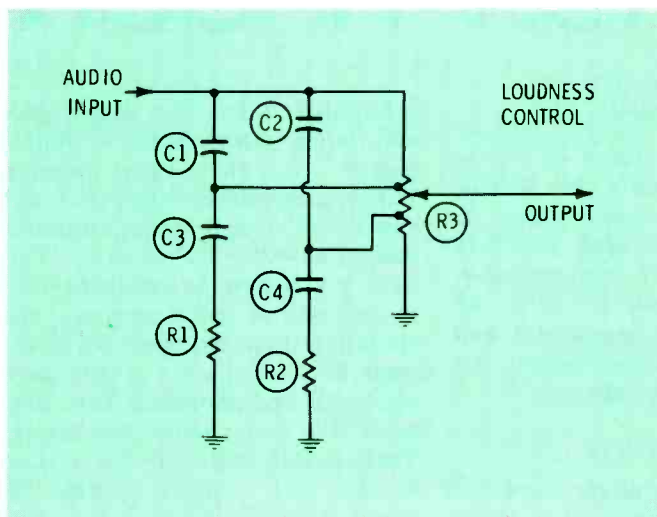

Fig. 6 This type of loudness-control circuit boosts both bass and treble as the volume is reduced, partially compensating for the Fletcher-Munson effect.

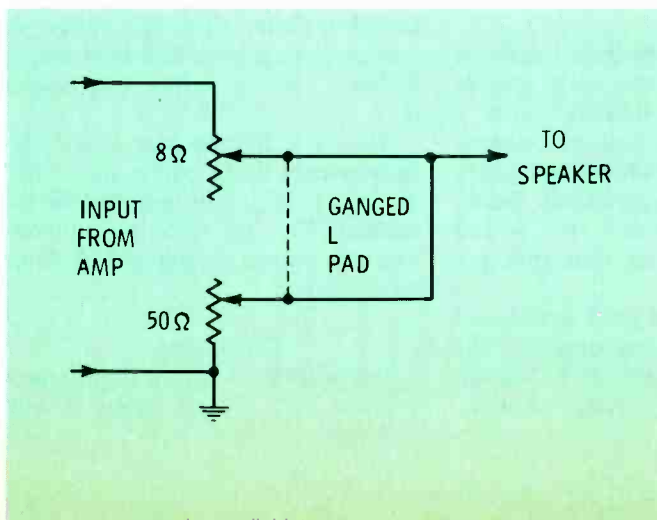

Fig. 7 "L" pads that adjust the volume applied to a speaker usually have two separate resistive elements. The circuit avoids loading the amplifier, and maintains constant input impedance at all levels, which a simple pot cannot do.



Ladder and antenna are tied to the luggage rack on top, removable signs are placed in the windows, tools and other equipment are inside, and Ted Youngman is prepared for an antenna installation.

STATION WAGON OR VAN?

By Ted Youngman, CET

We all know the value of a van that's operated only for service calls. But a station wagon is superior when it's used for both business and family transportation. These tips tell how to utilize all available space, move consoles, and construct a professional-looking, removable advertising sign.

A station wagon might serve you better than a van under these circumstances:

- if yours is a one-man business that needs the extra cash reserve possible by not buying both a personal car and a business vehicle;
- if your business volume has peaks requiring extra vehicles at times, but you don't want the added expense of trucks or vans that are used so little; or
- if you can reduce your equipment costs by paying employees by the mile to drive their own station wagons, instead of buying vehicles.

Granted, a van has more space and larger doors than a station wagon. But there are ways of minimizing these apparent advantages. A full-sized wagon is needed to haul TV consoles. Perhaps you believe in removing only the chassis of color receivers and operating them on a test jig in the shop. But consider the brands, such as Zenith and Motorola, that have removable covers under the chassis. These models often can be serviced in less time, without chassis removal, by access to the wiring side of the chassis when you take off the covering plate. Also, the entire set can be given a time-and-heat test in its own cabinet before you deliver it.

So, it's a definite plus to be able to transport those entire sets which are more-efficiently repaired in the cabinet. Tips for selecting a handy and economical wagon will be listed near the end.

Carpeting

Carpeting of the cargo space protects the wagon, your equip-

ment, and the customer's merchandise by minimizing any sliding.

Buy a 4' X 8' piece of carpeting. Used carpeting saves money and works just as well. If you buy new carpeting, the indoor/outdoor type is priced most reasonably. Don't fasten it down.

Roll the carpet forward when you need to uncover the hidden compartment at the rear. For business usage, the rear seat is folded. Then for passenger use, simply remove the electronic equipment, roll the carpet to the rear, and unfold the rear seat.

More Cargo Space

Make good use of the additional space in the hidden compartment, that's under a rear floor panel, by building a wooden box to fit the space. Add dividers to keep the items separated, preventing them from becoming a junk pile of wire and parts. Develop a standard loading procedure, and keep a list of items used, restocking daily as needed.

Luggage Rack

If your station wagon doesn't have a luggage rack on top, obtain one and install it. A permanently-mounted rack is more safe than a strapped or clamped-on type.

Tie down ladders and antenna boxes securely. Pieces of solid #12 or #14 wire are strong and handy to use, and a couple of coils around the ladder rungs and the rack will keep a ladder from sliding to the front or rear. Also, to prevent a dangerous sliding of the load, you should not accelerate or brake too suddenly.

Removable Signs

Signs are essential for any service vehicle; but they are not desirable, of course, when the station wagon is used for personal transportation. The answer is a pair of removable signs. I have made several sets for my own use, and have some suggestions for you.

First, make the signs attractive and professional-looking, and then mount them on the inside of the rear side windows where they will be protected from weather and vandals. Under some lighting conditions, the glass acts as a mirror that obscures the message. But most of the time, the glass en-

hances the appearance, just as if it were a picture behind glass.

Sign panel

My first sign was made of tempered masonite, but that was a mistake. Don't use any material that warps, is heavy, or costs too much. Next time, I bought a scrap of wooden wall paneling. It had three-ply, and I turned it so the grain of two plies ran horizontally.

After protecting unfinished surfaces with a coat of varnish, I covered the unfinished side with contact paper. Of course, you can use the finished side of the panel if you wish. Many such panels have grooves, but you can position the panel so the groove forms an underline for one row of lettering. Alternately, if your wagon has trim of wood-grain paneling, you can try to find a matching wood panel for the signs.

Make a pattern

Make a pattern of the rear window size and shape by covering the outside of the glass with wrapping paper (or sheets of newspaper taped together). Cut small slits (say 1/4" X 2") at several points on the paper, then hold the paper in place and cover the slits

with masking tape to secure the paper to the glass. Trim to size, but leave an inch or so extending beyond each edge of the glass.

Using your thumbnail, crease the paper along all four sides where the glass meets the window frame. Mark the crease using pen or pencil. Remove the paper and cut out along the marked lines.

Check the fit, by placing the pattern on the inside of both windows in turn. Alter it by taping extra pieces of paper to any areas not large enough, and cutting off any bulges. Try both windows, they might not be identical.

Place the wood panel with the correct side up on a flat surface, lay the pattern on top, line it up with the grooves (if any) of the panel, and mark around the pattern with a felt-tipped pen.

Using a sabre saw, slowly and evenly cut the panel along the **inside** of the line. If the panel tends to chip too much, stick a width of masking tape outlining the inside of the line on the front, and cover the approximate area of the back where the cut will be. It's not necessary for the tape on the back to be placed accurately. Place it so the cut will be through the center, and



Additional storage space is available in the compartment under the rear flooring. The hidden location offers some protection from thieves and vandals. A wooden box with compartments, built to fit the space, keeps components in order, and gives protection for test equipment.

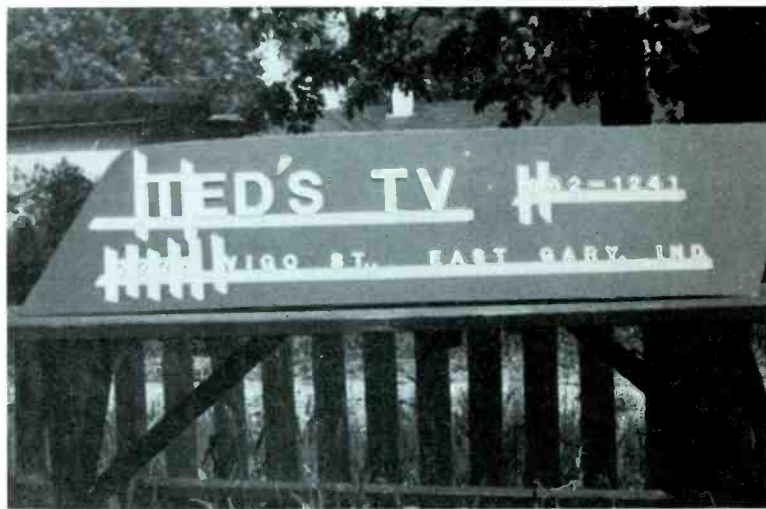

Strips of masking tape can help you maintain even spacing and straight lines when you apply the individual plastic letters and numbers. The strips can be removed easily afterwards.

then afterwards peel off the remains of tape.

My sign panels fit nicely, and are held in position by the rubber gaskets that hold the window glasses. If you are not so lucky, you might need to fashion several small metal brackets, using the screws of the window trim to secure them.

Lettering

When it's time for the sign lettering, remember the first impression many potential customers receive about you is gained from this sign. So advertise your business with the dignity it deserves. Don't use stenciled or messy free-hand lettering.

If you have a good sign painter in the neighborhood, get a bid from him for the job. Or you can buy stick-on type letters and numbers and do it yourself. Often you can find them in various sizes and colors. Don't use all one size or color, but don't change with every word, either. Perhaps your business name should be of largest size, with the phone number, or other information, in a different color and a smaller size. A number 1 turned on

its side makes a dash, or a number 1 at an angle serves as an apostrophe.

Don't clutter the sign! It's better to have a short message that people will read, than a crowded or unattractive one which will be ignored. Be artistic, if you like, but keep it simple.

For example, I belong to the local Indiana Electronic Technician's Association (IETA) and the state Indiana Electronics Service Association (IESA). I was tempted to add their logos to the signs, but I reluctantly concluded it would have been too much for the area available.

If you can't find letters and numbers that you like at your local hardware or novelty store, you might request descriptive literature and price lists from: Cole National Corporation, 5777 Grant Avenue, Cleveland, Ohio 44105.

For my signs, I obtained plastic letters and numbers that have adhesive already on the back, ready for installation. Strips of masking tape served well as guides for keeping straight the lines of letters. If you place a letter in the wrong

location, or at an angle, just slide it or remove and relocate it. The adhesive remains sticky for a time.

After you finish, try the completed signs in the windows; you'll be proud of your creation.

Here are the costs of both my signs:

scrap of 1/8" wall	
paneling	\$ 2.00
contact paper	\$ 2.07
large letters	\$13.86
small letters	\$17.40
varnish (on hand-no cost)	----
Total	\$35.33

Selecting A Station Wagon

The idea behind dual use of the station wagon is to save money, so I suggest you go all the way. Buy a good used wagon. Because of the gas shortage there are more for sale than usual, especially from individuals, so shop around.

It should be a full-sized four-door wagon, so you can load TV cabinets, and easily move your equipment in and out from either side.

Try to find a low-mileage wagon

The finished signs are neat and attractive, yet they can be removed in moments, when the wagon is needed for family transportation. Reflections on the glass cause the mottled appearance.

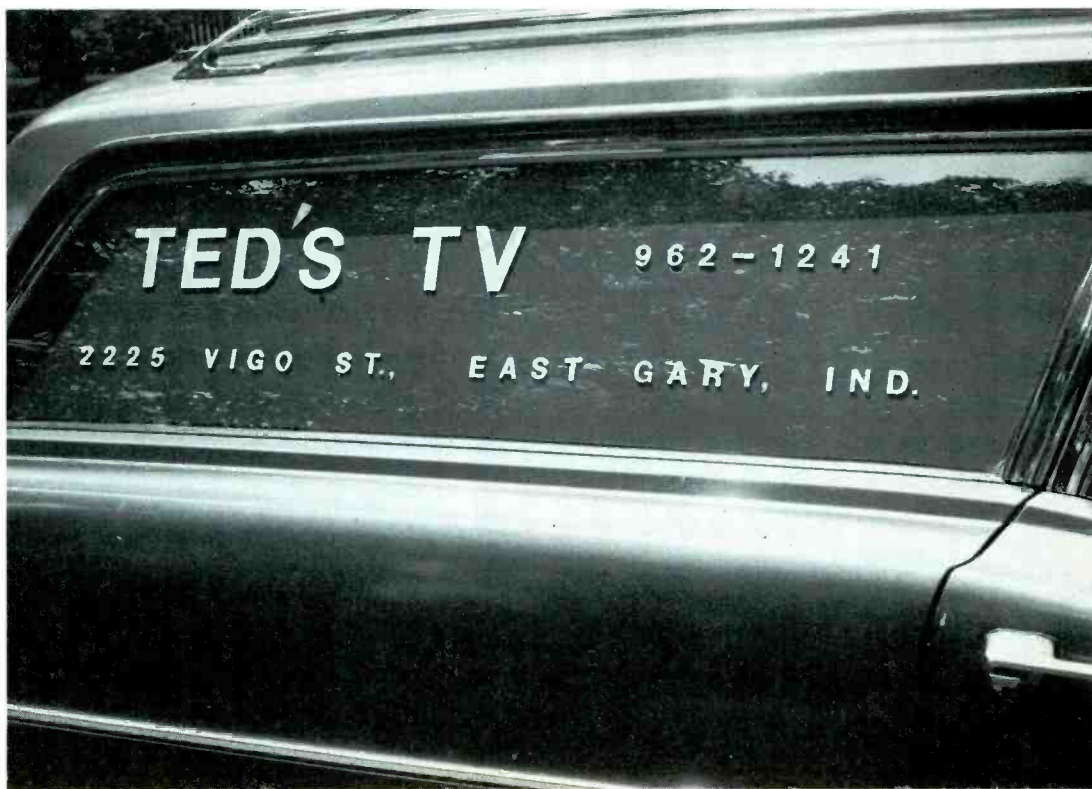



A full-sized wagon has sufficient clearance to permit the loading of most consoles, if they are turned on the front. The rug minimizes slipping, and makes damage unlikely.



With the rear seat removed and the center seat folded, it's easy to load caddies and equipment through a rear door of the wagon.

that has not been repainted, and shows no body rust.

Operation costs probably will be lower, if an older wagon without many anti-pollution gadgets is selected.

Although such options as power brakes, power steering, and air conditioning increase the cost,

sometimes they are worth the difference. Power steering helps greatly during parking of a heavily-loaded wagon in a tight space. And it's refreshing, after a service call in a hot non-air-conditioned home, if you can turn on the air conditioner, and arrive at the next service call cool and in a good humor.

high quality without high cost



IN A CONTROLLED
OUTPUT
SOLDERING IRON

BY **Weller**[®]

Model W-60. Versatile 60-watt, pencil-type tool with automatically controlled temperature and output. Only 7¼" long. Weighs but 2½ oz. Quick-change, anti-oxidation-coated ¼" screwdriver tip. Several other sizes available with choice of temperature outputs. Use with or without optional, mounted or free-standing bench stand PH-60.

Ask your local distributor or write...

**Weller-Xcelite
Electronics Division**



The Cooper Group

P. O. BOX 728,
APEX, NORTH CAROLINA 27502

For More Details Circle (20) on Reply Card



When the business day is over, and the family clamors for a picnic, it takes only a few minutes to remove signs and equipment, leaving the station wagon without any restrictions on personal use.

Here are some tips designed to keep maintenance and operating costs at a minimum:

- Inflate the tires two to four pounds more than factory-recommended pressures;
- Keep the engine in perfect tune. Replace the plugs and points **before** the engine begins to falter;
- Drive conservatively, without jack-rabbit starts or excessive braking. Your mileage will be better, and the maintenance less. Installation of a vacuum gauge provides a way for

judging economical acceleration; and

- Because of the many cold starts necessary in winter, a manual choke that you can adjust will improve performance and give better mileage.

Records For Taxes

For tax purposes, it is essential that accurate records be kept of the wagon expenses, and the ratio of miles driven for personal travel versus the miles necessary for the business. If you use the cost-per-mile method of calculating business

driving costs, it is imperative for you to have an accurate log of the mileage.

Summary

It's just as important to reduce expenses, thus controlling the outflow of cash, as it is to collect dollars for your service work. If you have a one-man shop like mine, you might be able to save on your expenses by using a station wagon for both personal and business travel. Vans are not noted for pleasurable family transportation.

The choice is yours.

For the Protection of ALL ELECTRONIC CIRCUITS

FUSETRON® dual-element — time-delay fuses

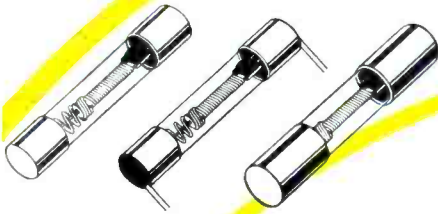

Avoid nuisance opening, yet get full short-circuit protection. Available from 1/100 amp. to 40. Size 1/4 x 1 1/4 in. and 9/32 x 1 1/4 in.

BUSS GLASS TUBE FUSES "quick-acting"

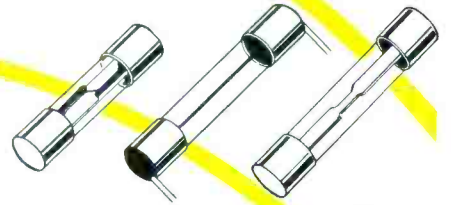

Provide high speed action to protect delicate instruments and apparatus. Available from 1/500 to 30 amp. Size 1/4 x 1 in. and 1/4 x 1 1/4 in.

TRON® rectifier fuses

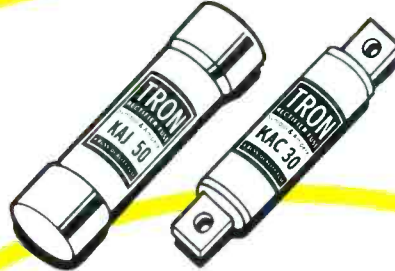

Provide extremely fast opening and high degree of restriction of let-thru current to protect Solid State Devices. Ampere rating 1/2 to 1000 in voltages up to 1500.

BUSS Signal-Indicating Alarm-Activating FUSES



Available with time-delay or quick-acting characteristics. Available from 1/10 to 30 amp. Size 1/4 x 1 1/4 in. and 13/32 x 1 1/2 in.

TRON® Sub-Miniature Pigtail Fuses

Size only .145 x .300 in. Glass tube permits visual inspection. Hermetically sealed. Available from 1/200 to 15 amp.



BUSS Fuses for TELEPHONE COMMUNICATIONS Similar equipment



BUSS SNAP-LOCK FUSEHOLDER

Rear panel mount fuseholder for 1/4 x 1 1/4 in. fuses. Snaps into place. Specify HTA-00 for space saver type. HLD-00 to take visual indicating fuses. HKP-00 for standard fuseholder. HJM-00 to take 1/4 x 1 in. fuses.



BUSS Sub-Miniature GMW fuse



and HWA fuseholder. Full size .270 x .250 in. with window to check fuse element. Available 1/200 to 5 amp.

HKP panel mounted fuseholder for 1/4 x 1 1/4 in. fuses.



HKA lamp indicating, signal-activating fuseholder.



BUSS® FUSES

For Quality — Reliability

For anything you need in protecting
electronic circuits and devices —

Write for Bulletin SFB

— See for yourself —

BLOCKS FOR BUSS FUSES

All types available for every application. Single pole, multiple pole, small base, laminated base, porcelain base for fuses from 1/4 x 5/8 in. up. Also signal fuse blocks and special blocks of all types.

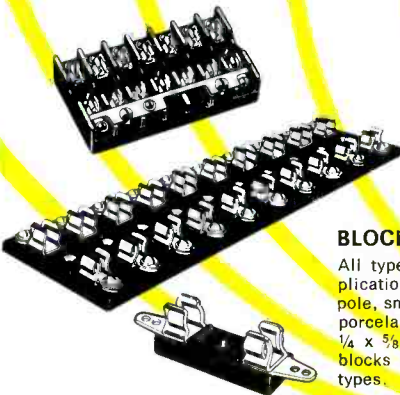

BUSSMANN MANUFACTURING
a McGraw-Edison Company Division
St. Louis, Missouri 63107





"I'll have to call in audio and video specialists."

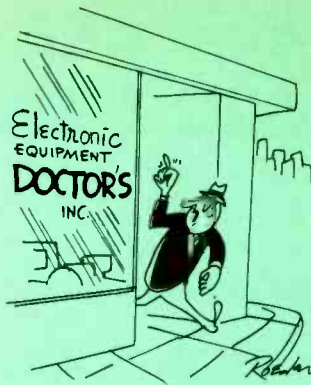

"The A.M.A. will hear about this!"

MEDICAL ELECTRONICS NOTEBOOK

Part 1/By Ed Bukstein

Perhaps the most difficult step for a TV technician who wants to begin servicing electronic medical equipment is the language barrier. These terms and definitions should help you get started.

A technician who repairs electronic medical equipment might be referred to as a "biochemical electronics specialist" (BES), a "biomedical equipment technician" (BMET), or simply as an electronic technician. The field is so new that the job title has not become universally standardized, and there are differences of opinion regarding the duties and training requirements.

But one fact remains certain and unchallenged. The person who troubleshoots, repairs, and adjusts medical equipment **must** be able to communicate with members of the medical community. This does not mean that a technician is required to know all medical terms, nor is he expected to understand the clinical aspects of medical science. But he should know enough of the specialized jargon to follow most instructions. If Dr. Jones phones and says, "Please come to the CCU, stat," the technician must know that CCU is **coronary-care unit**, and that stat means **immediately**.

Definitions And Pronunciations

The following list explains many of the terms used in hospitals:

Tachycardia (TACK-ee-CAR-dee-ah): an abnormally fast heart rate, typically in excess of 100 beats per minute.

Bradycardia (BRAD-ee-CAR-dee-ah): an abnormally slow heart rate, typically less than 60 beats per minute.

Myocardium(MY-oh-CAR-dee-um): the bands of muscle which make up the walls of the heart. It is the contraction of these muscular walls that pumps blood out of the heart.

Myocardial infarction (MY-oh-CAR-dee-al in-FARK-shun): a region of dead tissue in the wall of the heart, caused by blockage of blood supply to that region. This is a common cause of "heart attack."

MI(em-eye): an abbreviation for myocardial infarction.

CCU: an abbreviation for **coronary care unit**, a special area of the hospital where patients with heart problems can be closely monitored.

ICU: an abbreviation for **intensive care unit**, an area of the hospital where critically ill patients are cared for.

In a large hospital, there may be several ICU's operated by various

departments. For example, the MICU (medical intensive care unit) is operated by the Department of Medicine; the SICU (surgical intensive care unit) is operated by the Department of Surgery.

OR: an abbreviation for **operating room**.

ER: an abbreviation for **emergency room**.

Fibrillation (FIB-rill-ay-shun); a **quivering** of the heart rather than the forceful contraction required to pump blood through the body.

Ventricular fibrillation: fibrillation of the muscular walls of the ventricles, the main pumping chambers of the heart. This condition is fatal unless blood circulation can be restored within minutes. Emergency treatment includes electric shock to the heart. The shock is supplied by an electronic instrument known as a **defibrillator**, and is applied to the patient by means of a pair of metal electrodes (paddles) placed on the chest.

V. fib: a shorter expression meaning **ventricular fibrillation**.

CPR: an abbreviation for **cardio-pulmonary resuscitation**, an emergency treatment for someone whose heartbeat and breathing have stopped. Victims of heart attack or accidental electric shock often are found in this condition. The treatment consists of artificial breathing (mouth-to-mouth, for example) and



"If the Chinese can cure this way, I figured why not me!"

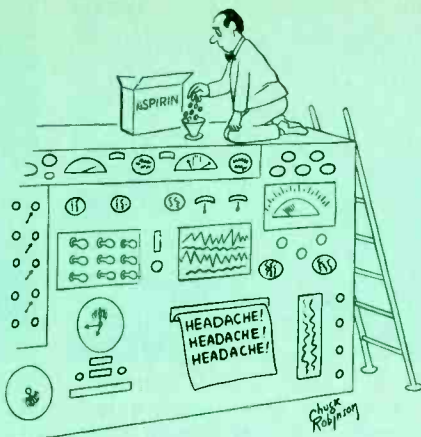

"Now that I've fixed the horizontal hold, I'd suggest you both see a doctor."

rapid, periodic compression of the chest to **squeeze** blood out of the heart.

QRS complex: the part of the electrocardiogram associated with contraction of the pumping chambers (ventricles) of the heart. Various portions of the electrocardiogram are identified by letters. The **P wave** is associated with contraction of the "input chambers" of the heart. These chambers, known as atria (AY-tree-ah), receive blood returning to the heart. When the atria contract, they force blood into the output chambers (ventricles) of the heart.

The QRS complex is related to contraction of the ventricles. The right ventricle pumps blood to the lungs to pick up a fresh supply of oxygen; the left ventricle pumps oxygenated blood to all parts of the body.

The **T wave** of the electrocardiogram is associated with relaxation of the heart between beats. During this time, the left and right atria refill with blood in preparation for the next cycle of heart activity.

Vital signs: the principle indicators of a patient's state of health. This includes heart rate, blood pressure and breathing rate.

BPM: beats per minute, the unit for specifying heart rate.

BP: abbreviation for **blood pressure**.

Stat: a shortened form of the Latin

statim, meaning **immediately**.

Arrhythmia (ah-RITH-me-ah): any abnormal rhythm of the heart.

PVC: abbreviation for **premature ventricular contraction**. These contractions of the ventricles occur too early in the heart cycle. They are triggered by electrical impulses originating within the heart, but from regions other than the normal source of these impulses. Because they do not follow the normal conductive pathways in the heart, these impulses arrive too soon and trigger the ventricles prematurely.

Telemetry: a system for continuously monitoring a patient's electrocardiogram while allowing the patient to move about freely. A miniaturized transmitter, about the size of a cigarette pack, is strapped or taped to the patient's chest. Two electrodes on the chest are connected to the transmitter so that the voltage from the heart will modulate the carrier.

At the nurses station, a receiver picks up the transmitted signal. After demodulation, the signal is applied to an oscilloscope for visual display of the patient's electrocardiogram.

Aorta: the large artery leading out of the left ventricle of the heart, and which subsequently divides into smaller and smaller vessels for distribution of blood to all parts of the body.

Paddles: large metal electrodes,

connected to a defibrillator, and held against the patient's chest for the purpose of shocking the heart (see **ventricular fibrillation**). The metal disks, typically two to three inches in diameter, are coated with an electrically conductive cream to lower the resistance at the skin-electrode interface.

Heavily-insulated handles are attached to the metal disks to protect the physician from electric shock. A pushbutton built into the handle permits the physician to "fire" the defibrillator while holding the paddles in contact with the patient's chest.

Crash cart: a cart containing emergency equipment and supplies. The cart is mounted on large casters so that it can be moved quickly to the bedside of the patient requiring emergency treatment. Typically, the cart contains a defibrillator, oscilloscope, and strip chart recorder, in addition to syringes and other purely-medical supplies.

The total vocabulary of medical science is large and complex, and even an experienced physician might refer occasionally to a medical dictionary. Therefore, a pocket-sized edition of a medical dictionary is a valuable addition to the technician's tool kit, even though it's not mandatory for him to have an extensive knowledge of medical terms.

Next Month

Some items of electronic medical equipment will be discussed next month. □

How to wire CB antenna connectors

Do you believe a wrong installation of an antenna connector on a CB transceiver can foul up the performance? Well, it certainly can; and here's the right way to wire them.

By Forest H. Belt, CET

There's a strange thing about Citizens-Band Radio. Almost everyone who can afford a CB transceiver seems to believe he's qualified to install it. Just give any beginner a drill, a wrench, and a screwdriver, and he thinks he's ready.

He might be able to do a good job, but most likely he's making work (and profit) for you. His installation probably will look as though it was hung in with bailing wire, and ready to fall apart. A layman doesn't worry about such niceties as good grounding (possibly he doesn't even know what it means). Worst of all is the neophyte's antenna installation. Usually, when he's done, he wonders why the rig works so poorly, and blames the manufacturer.

Standing-waves bounce up and down the antenna cable, shooting the VSWR sky high. Sooner or later, you'll probably get the job of redoing these messy installations.

As often as poor grounding, you'll find the antenna connector fouled. It shouldn't be, since most CB-antenna makers attach the connector at the factory. However, many a CBer tries to run the antenna cable from antenna to transceiver, instead of vice versa. Result: he tries to fish the connector through places only the 1/4-inch cable should go, and the connector often tears loose (sometimes inside where you can't see the damage).

After the cable has been damaged at the antenna connector, there's nothing to do but cut off the old connector, and reinstall it (or a new one). Now you might think this is an easy job (and it is, when you really know how). But, if you are not certain your method is perfect, go over the steps outlined here. They will put you on the road to success with coaxial cable wiring. No more callbacks because the VSWR has jumped suddenly and ruined the reception.

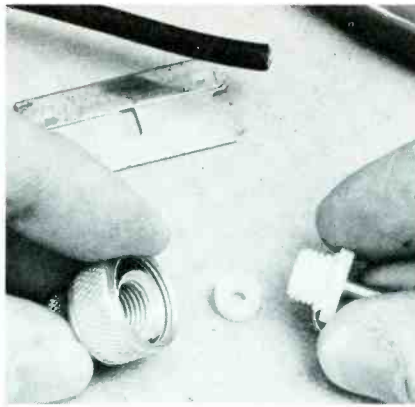

Step 1 Let's begin with a connector that's easier to wire, by using solderless connectors on the coaxial cable. You can buy them at most chain stores, like Radio Shack, Lafayette, or Olson. They're not as permanent as the soldered-on kind. They won't take much cable stress; you can pull out the cable without much tugging. And the inherent VSWR of a solderless connector is not so good as that of a properly-installed soldered type. But for a quick and simple cable connection, try a solderless. In the package, you get a shell and coupling ring, a small nylon spacer, and a center pin that's molded inside a threaded nylon collar.

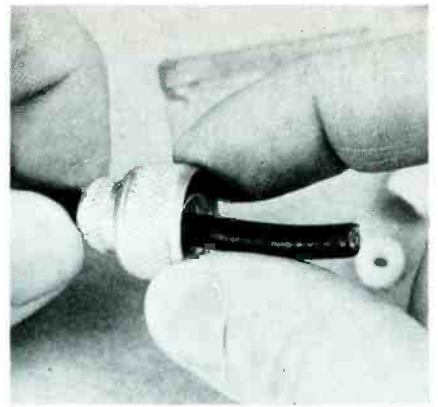

Step 2 Use diagonal cutters, or the cutter in your chain-nose pliers, to clip the cable end clean and straight across. A crooked cut causes trouble later. Slide the outer shell and coupling ring, which are already joined, onto the coaxial cable. Slide them well up out of your way.

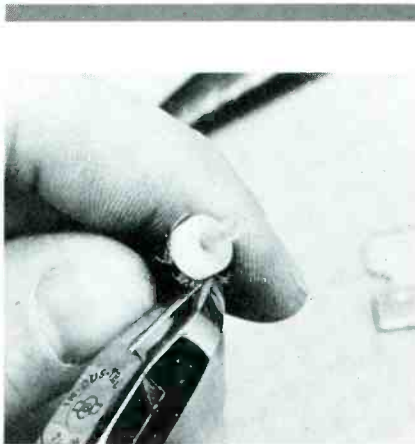

Step 6 Slide the nylon spacer, flat side first, down over the insulation of the center conductor. Jam it tightly against the folded-back shield braid. Now fan the shield strands outward. Again with your diags, snip off any and all strands that extend beyond the edge of the spacer's outer diameter. When you're finished trimming, none of the strands should reach down alongside the spacer. They should all lie snug against the flat side of the spacer. The insulated center wire protrudes from the concave side of the spacer.

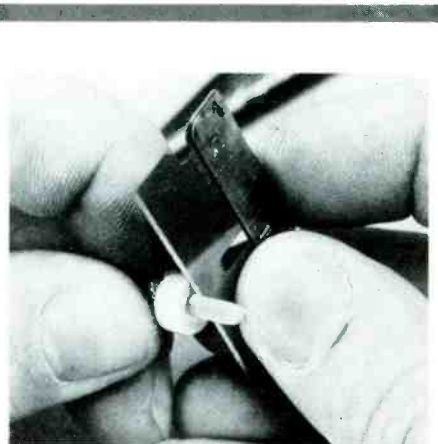

Step 7 Gently, with the sharp blade next to the spacer, circle the insulation of the center conductor. Your object is to sever the insulation there without nicking the wire inside. If you do accidentally nick the wire, cut off the whole cable end and start all over. A nick here virtually assures you of a bad connection. The center wire will break off inside the connector—very soon, if not immediately.

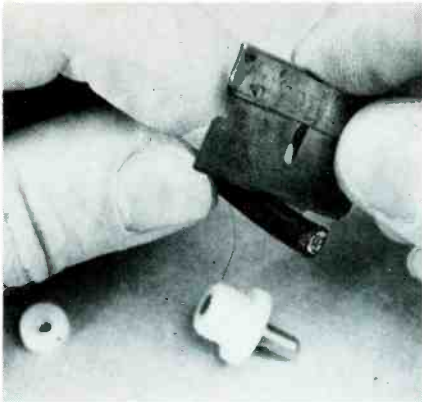

Step 3 A sharp razor blade makes the best tool for the next several steps. If it's dull, or you use a pocket knife, you may cut through more than you should. Try a delicate touch. Circle the black vinyl outer sheath with the blade, a little more than 1/4 inch (and less than 1/2 inch) from the end. Slice only deep enough to sever the vinyl sheath. You don't want to nick any of the strands in the braided shield underneath the black covering. With your fingers, you should be able to twist loose the severed length of the sheath and slide it right off over the end.

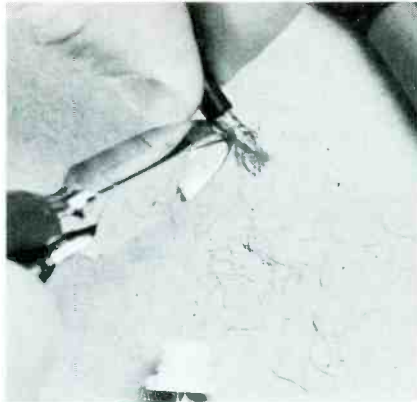

Step 4 That leaves about 5/16 inch of braided shield exposed. Now you need a pair of diagonal cutters with fairly sharp tips. Using them, cut off all except 1/8 inch of the braided shield. Take care that the diags don't nip the soft insulation between the shield and inner conductor. And be sure you clip all the strands. If you leave even one strand longer than 1/8 inch, your whole job might be futile; that strand very probably will find a way to short out the connector.

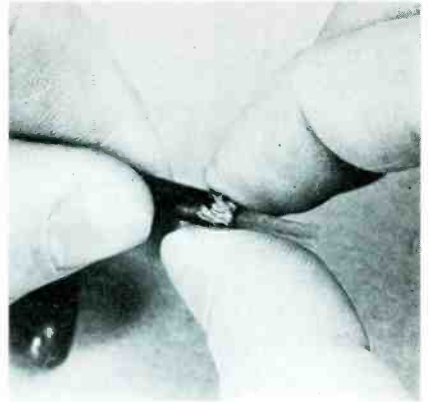

Step 5 Here you fold back the 1/8 inch of braided shield—backward over the vinyl covering. This gives you another chance to make sure no strands remain longer than 1/8 inch. You may want to even up the strand ends, making them all exactly the same length. Spread and fold the tiny wires in such a way that they form a sort of ferrule around the end of the cable sheath. You have left now, protruding from the end of the cable, about 5/16 inch of center conductor covered by soft insulation.



Step 8 With channel-nose pliers, bend a tight loop in the exposed end of the center conductor. The diameter of the loop must be smaller than the diameter of the spacer. In fact, the loop should fit neatly down in the slightly-concave face of the spacer.

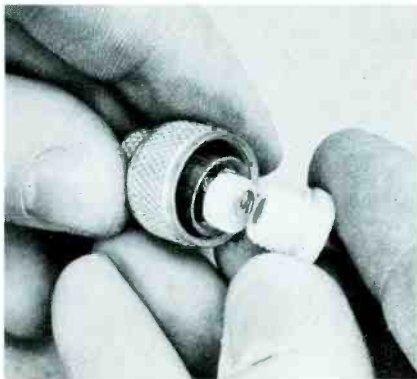

Step 9 Recheck everything. The spacer should be snug against the strands of the braided shield, held there by a tight little loop of the center conductor. No strand of the braid should extend over the edge of the spacer. Slip the shell and coupling ring down to the spacer. Screw the pin assembly, with its threaded nylon collar, into the threaded barrel of the connector shell. The pin, since it extends all the way through the molded collar, presses firmly against the loop formed of the center conductor. The shell barrel binds tightly against the shield strands, completing the ground side of the cable circuit. With pliers, firmly tighten the pin assembly in the barrel.

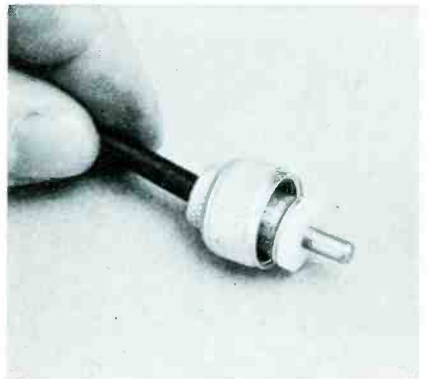

Step 10 Here's the finished product. When meticulously done, a solderless connector terminates coaxial cable satisfactorily. But remember to check VSWR periodically; if it takes a jump, suspect the connector first of all. You need only a few minutes to cut off the cable end and install the connector anew.

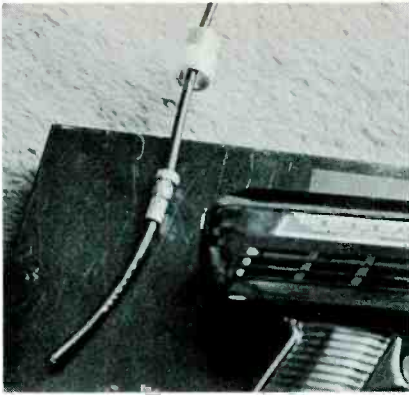

Step 11 A standard PL-259 connector fits large 1/2-inch coaxial cable, which is rarely used for CB installations. So, buy an adapter ferrule that fits the 1/4-inch cable and screws into the shell of the PL-259 (later). Begin by cutting the cable straight across, as you would for a solderless connector. Unscrew the coupling ring from the PL-259 body, and slide it onto the cable with its threads nearest the cable end. Then slip the adapter ferrule onto the cable, with the tapered end out.



Step 12 Some technicians prefer a sharp knife for this step, claiming that they're not as apt to cut all the way through the center conductor as with a razor blade. Maybe...maybe not. Whichever you use, make a circle 2 inches from the end of the cable. Then cut **all the way** to the center conductor. BUT, be cautious you don't nick the center wire. That would make a very weak connection. You should start over if you do happen to nick the wire. Cut through and remove the first 2 inches of vinyl outer sheath, shielded braid, and inner insulation. Leave only 2 inches of bare center wire sticking out.



Step 13 Move back another 1/2 inch and circle only the vinyl outer sheath. Sever it, twist it loose, and slide it off the end of the cable. Do your best not to nick any of the shield strands. You depend on them to maintain shield continuity with the connector. Otherwise, energy transfer is poor between transceiver and antenna. Efficiency of communications goes right down the drain.



Step 17 Pick up the body of the PL-259 connector. Poke the bare center wire down the barrel and through the hollow pin in the center. Holding the ferrule and cable with one hand, with the other screw the PL-259 body onto the ferrule. After you have it finger-tight, grasp the connector body with one pair of pliers and the ferrule shoulder with another. Twist them tightly together. This assures that the shield strands, lying on the ferrule taper, make solid and tight contact inside the shell of the connector body.

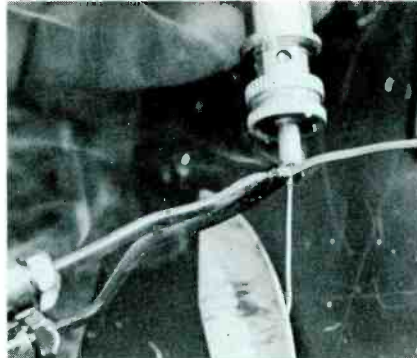

Step 18 Tug a bit, but not too hard, on the bare wire end—to seat the insulated portion snugly into the pin insulator inside the connector. Then solder the bare wire at the tip of the connector pin. Don't run a lot of solder down into the pin. Enough solder draws up into the pin by capillary action when you apply a well-preheated soldering iron or gun. Take the heat away as soon as solder melts and flows into the pin. Too much solder drips down inside. Too much heat melts away the inner-wire insulation, up inside the connector. Either one causes shorts.

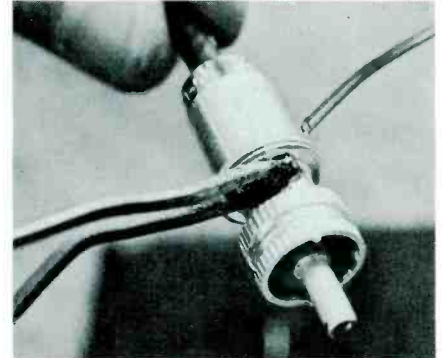

Step 19 You can apply a bit of solder to the shield strands, through a hole in the shell of the connector body. You may find two or three holes, but solder through only one of them—to avoid applying more heat than may be advisable. Some technicians get by without this extra touch. If you try to, make sure the tapered ferrule has gripped the shield strands tightly inside the connector body. (You can try tugging the cable out of the shell before you solder the center wire in the pin. You should fail.) Finally, screw the coupling ring down onto the connector body, and you're ready to test the connector.

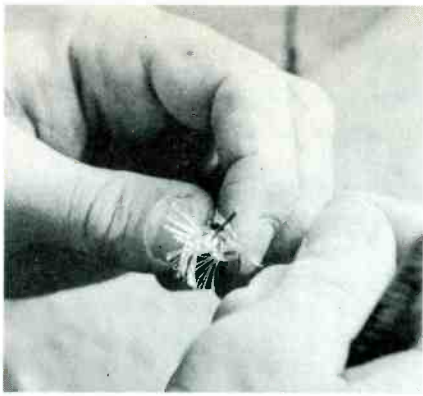

Step 14 Fan out the strands of the shield. Spread them, and separate them. That exposes 2-1/2 inches of wire, with 1/2 inch covered by insulation.

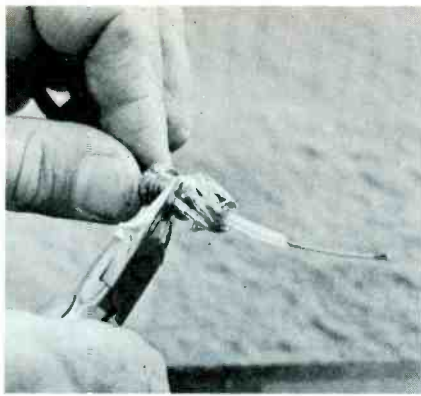

Step 15 Slide the adapter ferrule down until its end lines up with the end of the black vinyl sheath. Fold the strands of the shield back over the tapered end of the ferrule, toward the threads. Then, with your sharp-tipped pair of diagonal cutters, snip excess length from the braid strands.

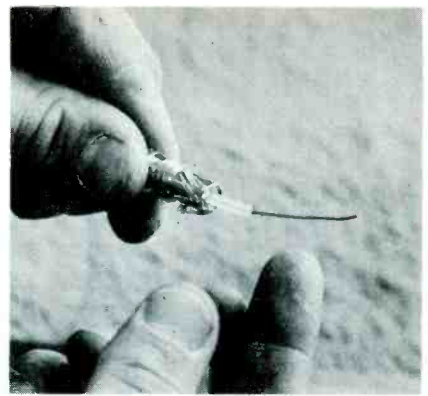

Step 16 When you've finished snipping, no strand should quite reach the threads on the ferrule; they should just cover the taper. Your cable end now should consist of a 2-inch length of bare center wire, a half-inch of insulated center wire, and the ferrule with its taper covered by the folded-back shield strands.

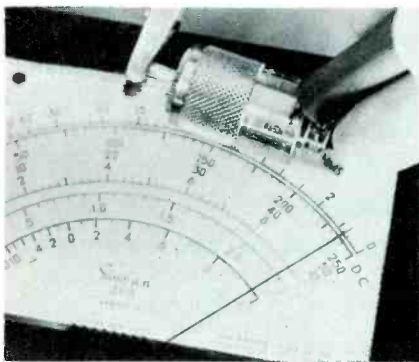

Step 20 Possibly the quickest way to check the connector is by measuring it with an ohmmeter. Clip one test lead to the center pin and touch the other to the shell. If you get a low ohms reading, as shown here, the connector—or possibly the cable—has a short in it. Look at the antenna end of the cable, to make sure there's no short there, before you cut off the connector and try again. (Once you have cut it off, measure again with the ohmmeter; then you'll know for sure the fault is in the connector instead of somewhere undiscovered in the cable or antenna.) If your ohmmeter test finds no short, leave the one test lead clipped to the center pin and try touching the other to the center wire at the antenna or to the rod of the antenna itself. This should bring a very low ohms reading, proving con-

tinuity from connector pin to antenna. That being okay, clip one test lead to the connector shell and touch the other to the cable shield at the antenna. Again your ohmmeter should reveal continuity (low ohms reading).

You also can test the connector by hooking up a reverse-sampling wattmeter (or a VSWR meter) between transmitter and antenna cable. Forward reading should be about ten times the Reverse (or Reflected) reading. Much power sent backward toward the transmitter from the antenna side of the meter signifies (1) a short or open inside the connector, (2) a defect in the cable, or (3) a broken connection or short in the antenna itself. You can only surmise which, unless you devise a way to insert the VSWR meter or wattmeter at the antenna end, between cable and antenna. There, a wattmeter finds only low output (weak Forward reading) if the cable or connector is bad) a high Reverse reading there points to a defective antenna.

A CB antenna connector remains susceptible to faults, even when installed right. If the transceiver must be taken out and put back in repeatedly, often the case nowadays with truck installations, the cable takes a beating where it joins the connector. Anytime a CBER complains of poor distance with his rig, suspect

the antenna connector. Test it as I just described. If you're in doubt, installing a new connector doesn't really take all that long; cut off the old one and do it.

Finally, for installations you handle yourself, arrange the antenna cable so it doesn't bend sharply where it leaves the connector. See also that there's no steady weight or pull on the cable. Make connections to the antenna carefully, so lugs don't get bent. Be sure they're secure. Cable ties do more than make an installation look nice; they protect the coaxial cable from unseen damage. You can bet: a neat installation, with connector put on the right way, stays trouble-free indefinitely.

Next Month

Watch for the next two articles in my CB series. I'll show you, in sharp pictures, how an expert installs a CB rig in a big over-the-road truck. That's one of today's most-popular [and sometimes most-difficult] installations. You'll see how to fish the coaxial cable out of sight, and out of the way of damage; and how to avoid crimping it in windows or vents, the way so many amateurs do. □

SCAN RECTIFICATION... How is it different?

By Charles D. Simmons

New low-voltage power-supply circuits called "scan derived", "scan rectification", or "electronic power supply" are found in many late-model solid-state color TV receivers. All these power supplies produce a useful DC voltage by rectification of either the pulse or scan peak of the horizontal-sweep signal, so various power-supply malfunctions can cause bewildering symptoms.



er to filter than the 60-Hz ripple from a conventional half-wave supply. That means a smaller-capacitance peak-reading input capacitor can be used. However, many schematics show capacitor values of much-larger sizes than necessary to achieve a peak-reading condition. We can conclude only that those larger capacitances help stabilize against line-voltage bounce, thus giving more-steady operation, or they are required for better isolation of the various circuits.

But regardless of the reasons for using sweep rectification, the fact remains that the circuits are here, and must be understood and serviced.

Pulses and Polarities

Exactly the same rules of electronics apply to pulse rectification as to sine-wave power supplies. However, many conventional explanations omit some of the guidelines that are essential for pulses, but are taken for granted with sine waves and the RMS specifications.

A later article will offer proof of the statements made here. For now, accept them and look forward to the explanations.

Polarities

Regardless of the waveform of

Input AC for a sweep-rectified power supply is obtained from the horizontal-sweep circuit, usually from a winding of the flyback transformer. However, the DC voltage for the sweep comes from a conventional DC power supply that's operated either direct from the 120 VAC line, or from a power transformer.

This seems to be useless duplication, for the usual DC supply is not eliminated, but extra sweep-rectification components are added. There must be some sound reasons why a manufacturer would allow the additional expense.

Advantages Of Sweep Rectification

From a design engineer's viewpoint, sweep rectification makes

sense. One advantage of the old-fashioned power transformer is that several isolated windings can be supplied, and each can be rectified to a different DC voltage. This eliminates the wasted power, excess heat, and the poor voltage regulation that are drawbacks of the alternate way of using dropping resistors to provide several different DC voltages from a higher one.

Taking the AC voltage for a rectifier from the horizontal flyback transformer is important because a flyback offers the advantages of multiple isolated windings, but the flyback can run cooler and be made smaller and lighter than a 60-Hz transformer of the same power rating.

The 15,734-Hz ripple from a sweep-rectifier circuit is much easi-

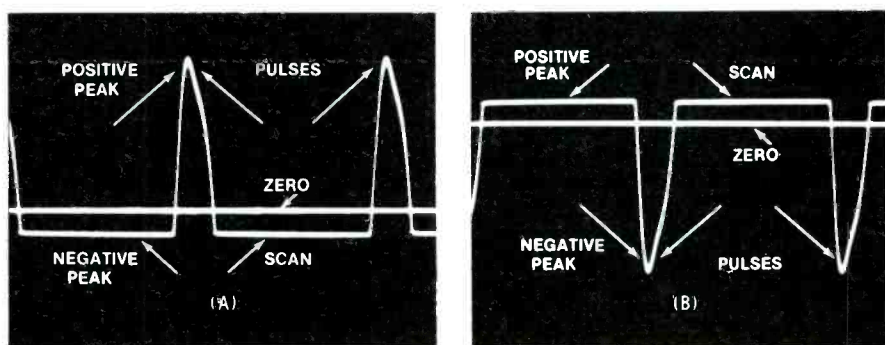

Fig. 1 A diode rectifier operates on the voltage between the appropriate peak and the zero point of the AC input voltage. The amount of DC voltage obtained from rectifying pulses, such as the ones from horizontal sweep, depends on which peak is rectified. Rectification of the positive peak of "A" would produce a much larger positive voltage than would rectification of the positive peak of "B". In the same way, the negative peak of "A" would yield a low negative DC voltage, and the negative peak of "B" would produce a larger negative DC voltage after rectification. In practice, the ratio of the DC voltages obtained from the two peaks varies between three times and five times, depending on the width of the pulses and the load on the supply.

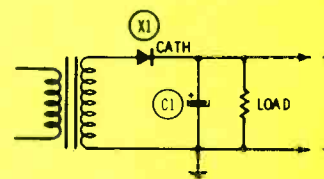

Fig. 2 This half-wave peak-reading rectifier circuit is a series type, with the correct diode polarity for rectification of the positive peak, which will produce positive DC at the load. For rectification of the negative peak, just reverse the polarity of the diode, and the output then will be negative DC.

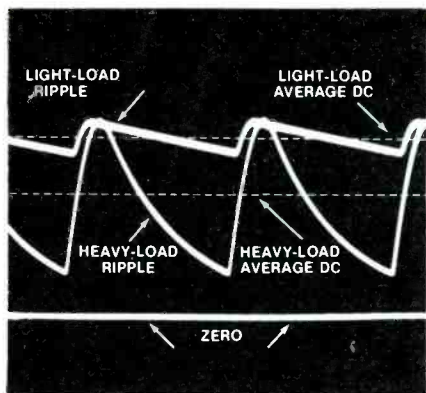

Fig. 3 Examine this multiple-exposure waveform carefully; it's probably the first time it has ever been published. Shown here are the DC voltages and ripple waveforms of a certain peak-

reading power supply operated with two different resistance output loads. If we add the average-voltage (dotted) line to the small sawtooth waveform at the top, it shows the true characteristics of the output DC voltage under a light load. With a calibrated DC scope, the number of calibration marks from the average-DC point to the zero line at the bottom shows the average DC voltage, which is exactly the same as if measured on a DC meter. Next month, we'll show you how to find the average voltage of different waveforms by using your own scope. Also, the peak voltage of the input AC is measured between the top peak of the ripple and the zero line (double it for peak-to-peak, since this is a sine wave).

Peaks

One important point, not often mentioned or emphasized, is that a **single** rectifier circuit conducts **only** according to the voltage of **one** peak of the input AC waveform. In other words, a diode operates from the maximum voltage measured from the zero-voltage point to either the positive peak or the negative peak, whichever is used in that particular circuit.

Probably this truth was obscured by the old truism that the peak voltage (on which the diode works) equals 1.414 times the sine-wave RMS voltage.

Pulses

The zero-voltage line (showing the average voltage) of a **sine wave** goes horizontally across the exact center. That one was easy. Now, where is the zero-voltage line for pulses? Careful, because the correct answer is "It depends". Generally speaking, the zero line is much nearer the base line than it is to the tips of the pulses. However, the precise spot depends on the **shape** of the pulses, and particularly on the pulse **width**.

Figure 1 pictures waveshapes typical of those in transistor horizontal output stages, and the zero line (supplied by the scope) is shown in each case.

One of the major factors determining the amount of DC obtained by rectification of such pulses, then, is which of the peaks is being rectified. Series and shunt peak-reading rectifier circuits conduct on the opposite peak, for the same polarity of output DC voltage.

However, we will consider only the series type of circuit. The shunt kind is never used alone for a DC power supply because of the excessive ripple.

Without specifying exact figures, let's look at the waveform of Figure 1A, and make some general assumptions. A series peak-reading rectifier circuit (such as in Figure 2) with the anode of the diode to the AC and the cathode to the DC would conduct on the positive peak. Now, most of the amplitude of the total waveform is in this positive peak, so a lightly-loaded circuit would produce a positive DC voltage exactly equal to the voltage between the zero line and the positive peak. That's a high voltage compared to the one next described.

On the other hand, if the polarity of the diode is reversed, the diode would conduct during the negative peak, and, if the load is light, produce a negative DC voltage that's exactly equal to the voltage between the zero line and the negative peak. Obviously, this will be a smaller voltage than the positive one.

The larger almost-sawtooth waveshape has been shifted slightly to the right for clarity. It traces the variations of instantaneous DC voltage from the power supply when it is heavily loaded. In both waveforms, the rising portion has the same shape as a section of the input sine wave, and the falling side must follow the classic capacitor-discharge curve for the amount of time between cycles. Both statements are proved by the lower waveshape. Again, the average-DC dotted line shows the DC voltage, which is about 33% lower than the output voltage when lightly loaded. These waveforms illustrate the wide variation of DC voltage and ripple amplitude that occurs when the load on a power supply is changed greatly.

Judging from the amplitudes of the two peaks as shown, **the positive DC voltage would be almost six times that of the negative voltage**. Perhaps you can appreciate now why it's important to know the waveshape and the polarity, in addition to the total amplitude of any AC signal used as an input for a power supply.

And that's not all. Operate the

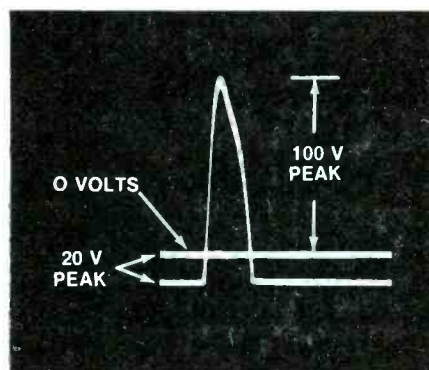

Fig. 4 A perfect series peak-reading rectifier should produce +100 volts from this waveform. Of course, that's the same as the voltage of the positive peak. Also, a perfect series peak-reading rectifier should produce -20 volts from the same waveform, by rectification of the 20-volt negative peak. Figure 3 showed how a heavy load can reduce the output voltage, and the article explains the effects of the different conduction times when the two peaks are rectified. In practice, a pulse rectifier might produce a DC output of 70% of the p-p input, if lightly loaded, or a heavy load might reduce that to 30%. Scan supplies might produce from 20% to 10%, depending on loading.

waveform of Figure 1B in the same circuit and you'll find the negative voltage to be about six times the positive voltage.

From the preceding, we can conclude correctly that a designer has the options of obtaining (from waveforms of the same amplitude) either a high or a low DC voltage, of either positive or negative polarity, by selecting the polarity of the pulses and the polarity of the diode.

Pulse Versus Scan Rectification

Rectification of any horizontal-sweep waveform can be considered "scan" rectification, because the signal is from the scanning circuit. However, there is a more precise shade of meaning, because the **pulses** occur during **retrace** of the horizontal sweep, and the **base line** between pulses occurs during the **scanning** part of the sweep.

Therefore, rectification of the pulses is called "pulse rectification", and rectification of the low-amplitude opposite peak is called "scan rectification".

Because these two peaks are so different, it follows that the results obtained from rectifying them also will be equally different. The pulses

have a high amplitude, but are narrow (short duration), so the DC voltage obtained from rectifying them is comparatively high. But the limitation is that the short conduction time demands, for a certain wattage, that the current must be extremely strong. This brings the danger of excessive load on the sweep system during pulse times, with the resulting decrease of high voltage that's supplied to the picture tube.

Rectification of the scan peak produces a relatively low DC voltage, but the conduction current flows for a much longer period of time during the trace period, when the circuit is less susceptible to the amount of loading.

General Electric states that DC current originating from pulse rectification should not exceed about 20 milliamperes to avoid excessive-loading problems. On the other hand, scan supplies between 10 and 50 volts might operate at 100 to 400 milliamperes without representing excessive loads.

Peak And Average DC Voltages

When you check the peak-to-peak versus DC voltages in actual receivers, it's likely you will find

much less than a six-times difference in DC voltages according to the polarity of the waveform.

This does not mean the theory is wrong, it just illustrates another difference caused by the waveform. Figure 3 shows the wide variation of average DC voltage and ripple amplitude and waveshape between a lightly-loaded peak-reading rectifier and one that's heavily loaded. In this case, the heavier load discharges the peak-reading capacitor to a lower voltage between the replenishing pulses, causing a decreased average DC voltage along with a larger ripple amplitude.

With pulse and scan rectification, there is a slightly different effect caused by the difference in the length of time that diode conduction occurs. Look at it this way: When pulses are rectified, conduction occurs for a very short time (obviously, it can't continue for longer than the width of the pulse, no matter what else), and that allows a longer period of time for the DC voltage to decrease before the next pulse.

However, scan rectification forces the diode current to continue for most of each cycle, and that allows the DC voltage very little time to

Fig. 5 Three pulse-rectified supplies are used in the Admiral M10 chassis. Notice that the +235 voltage is made up of +120 volts from the DC supply to the horizontal-output transistor plus about +115 volts from pulse rectification. An open F1000 fuse causes loss of vertical sweep and no sound, except for some buzz.

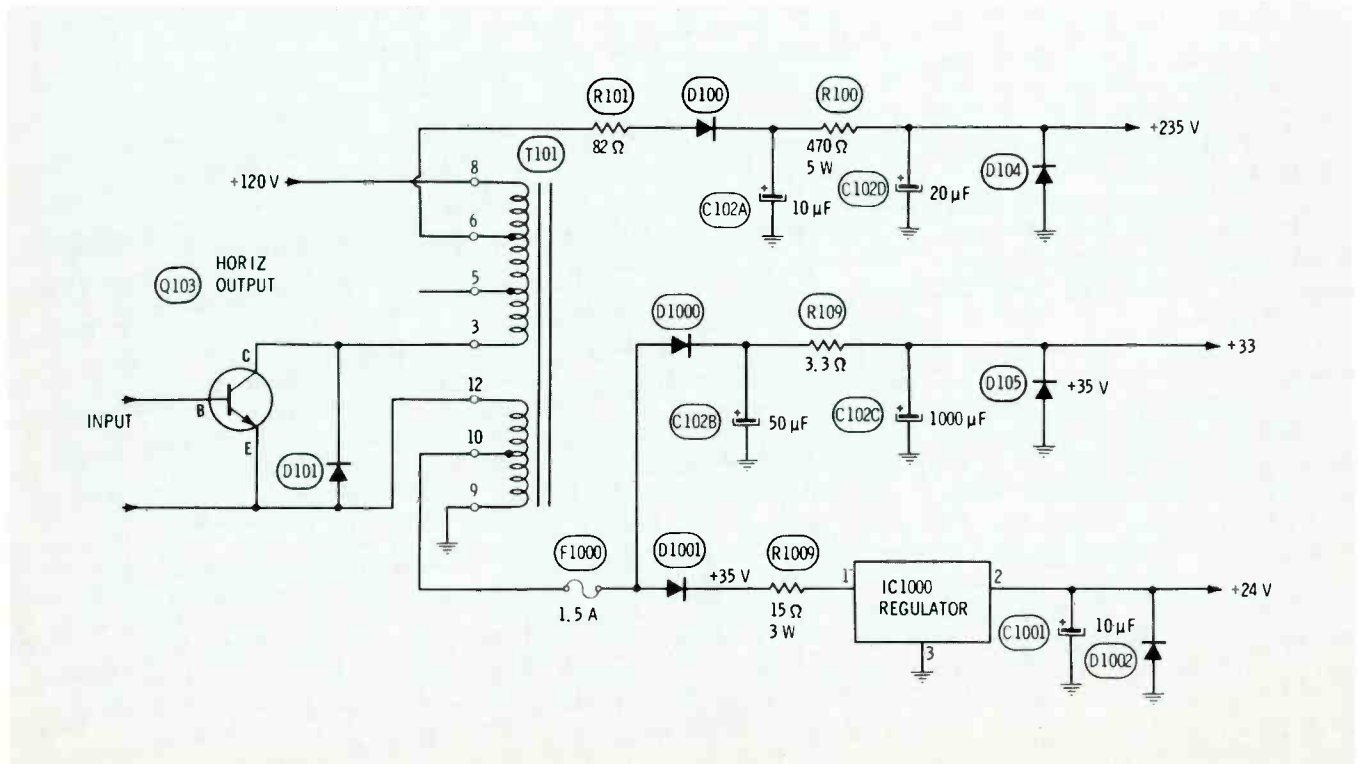

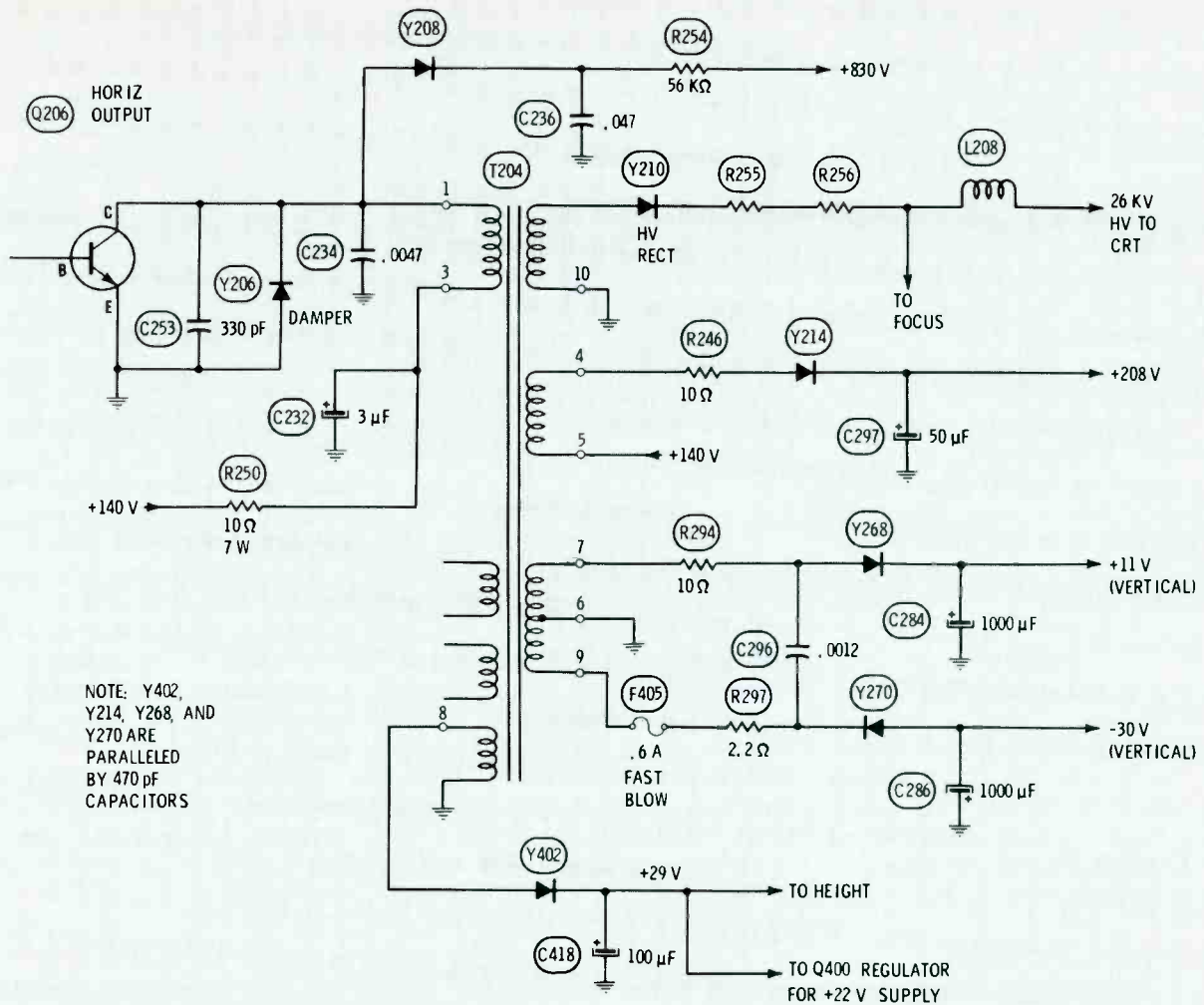

Fig. 6 The General Electric 19FA chassis has one pulse-rectifier supply and four scan-rectifier supplies. Y268 and Y270 diodes are on the vertical module, so if there's a doubt that excessive vertical current is blowing the fuse or reducing the high voltage, the module can be unplugged as a test.

decrease between cycles.

Those are the reasons for the apparent failure of pulse rectification to attain the full DC voltage that's theoretically possible. (Figure 4).

Now that the basics have been covered somewhat, it's time to study some actual circuits.

Admiral Scan-Derived Power

Three "scan-derived" sources of DC voltage are found in the Admiral M10 chassis (Figure 5). All three are supplied with positive-going pulses (pulse rectification), but they differ in other respects. D1000 rectifies pulses from the emitter winding of the flyback, and produces +33 volts after filtering. D105 is there only to clip any transients, such as arcs, that origi-

nate outside the supply.

D1001 rectifies the same pulses, producing +35 volts, which is regulated by IC1000 and becomes +24 volts. IC1000 is a special three-terminal IC made for regulator use.

The +235-volt supply seems to be similar, but there are two differences. First, the amplitude of the pulses is much greater, coming from the collector part of the flyback winding. And secondly, the rectified voltage is in series with the +120-volt regulated supply. In other words, the pulse rectification supplies about +115 volts, and the conventional power supply adds +120 volts for a total of +235.

General Electric

General Electric color receivers using the 19JA chassis (Photofact

1328-2) have a total of **five** scan and pulse rectifier supplies (Figure 6), which seems to be some kind of record.

Starting at the top of the schematic, Y208 rectifies pulses from the collector of the horizontal-output transistor, producing about +690 volts, which is added to the DC collector voltage of +140 to make +830 volts used for the screen grids of the picture tube. High voltage is conventional, except for the single rectifier, and is included for reference, because it is pulse rectification, also.

Y214 furnishes about +70 volts, and this supply is returned to +140 volts, thus making the total scan supply output about +208 volts.

Vertical sweep output transistors are powered by the positive and

negative voltages from the Y268 and Y270 supplies. Both rectify the scan portion of the waveform (negative pulses to Y268 and positive pulses to Y270) so they can furnish heavy current. Other YA chassis have +13 and -13 voltages.

Y402 also is a scan rectifier of flyback signal from a different tap. The B+ supplies the height control and the regulator transistor (Q400) for the +22-volt supply, which powers most of the signal-processing circuitry.

Any serious overloads in these power supplies blows the fuse for the +140 power. It might be necessary to disconnect one diode at a time to locate the supply causing the fuse to blow. Removing the vertical module disconnects both Y268 and Y270, because they are on the module.

Quasar

Sweep rectification in the Quasar TS941 chassis (Figure 7) is quite different from the others. Notice that the AC for the D2/+210-volt and the D3/+20-volt supplies comes from different windings of the **horizontal-driver transformer, not the flyback.**

Another major difference is the waveform. At the driver transformer, the signal is nearly a square wave, so neither supply can be called a pulse or scan type of rectifier.

As explained last month in "Servicing Modular Color", the voltage of the +20-volt supply and the amplitude of the drive to the base of the horizontal-output transistor both are regulated by taking a sample of the +20 volts as forward bias for Q4, the voltage-regulator transistor, which in turn adjusts the bias of the horizontal-buffer transistor, thus determining the gain.

Servicing Scan And Pulse Rectifiers

Logical troubleshooting of sweep-rectified power supplies is much more frustrating and difficult than working with conventional circuits.

Suppose the DC voltage from a pulse rectifier is low. Is the cause a defect in the rectifier circuit, or is it because of insufficient AC voltage from the flyback? On the other hand, excessive load from the sweep-rectifier supply can reduce the amplitude of the flyback volt-

age. In which direction is the defect?

And I shudder to think of a universal-replacement flyback that gives the correct p-p voltage from a certain winding, but has the wrong polarity of pulses for the sweep rectifier. Of course, the same serious problem can happen if a technician goofs and reverses two wires at the flyback. How many components will blow when a 20-volt supply attempts to be about 80 volts, and before the fuse opens to stop the damage?

Summary

The polarity of the DC voltage from any scan, pulse, or sweep rectifier circuit depends **only** on the **polarity of the diode.**

And whether the DC voltage is high or low compared to the total amplitude of the AC waveform is determined by the **polarity of the waveform.** Those are the two most-important facts to remember about sweep rectifiers.

Next month, some original and interesting information about power supplies in general, and sweep rectification in particular, will be discussed. □

Fig. 7 Two sweep-rectified supplies are found in the Quasar TS941 chassis, but the AC comes from the horizontal-driver transformer, not from the flyback.

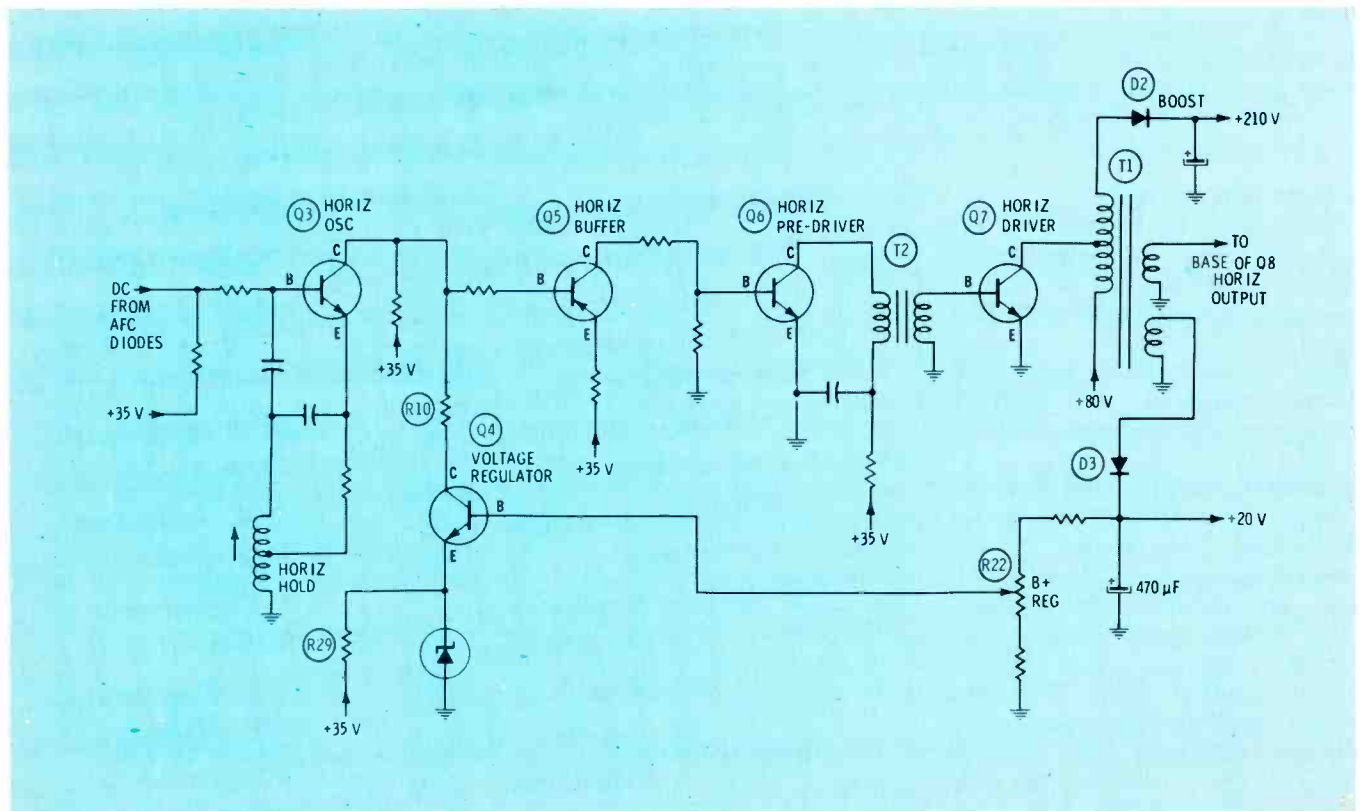

ELECTRONIC MERRY-GO-ROUND PUZZLE

by Edmund A. Braun

If you can go around in a revolving door without getting dizzy, you'll have fun going around this Pinwheel Puzzle based on the terminology of electronics. The last letter of each word is the first letter of the next word. Each correct answer is worth 4 points; a perfect score is 124. It should be fairly easy to get a high rating, except perhaps for someone who thinks a "booster" is a male chicken, or that "Dellinger" was a fugitive of the FBI! So sharpen your pencil, make yourself comfortable, and GO!

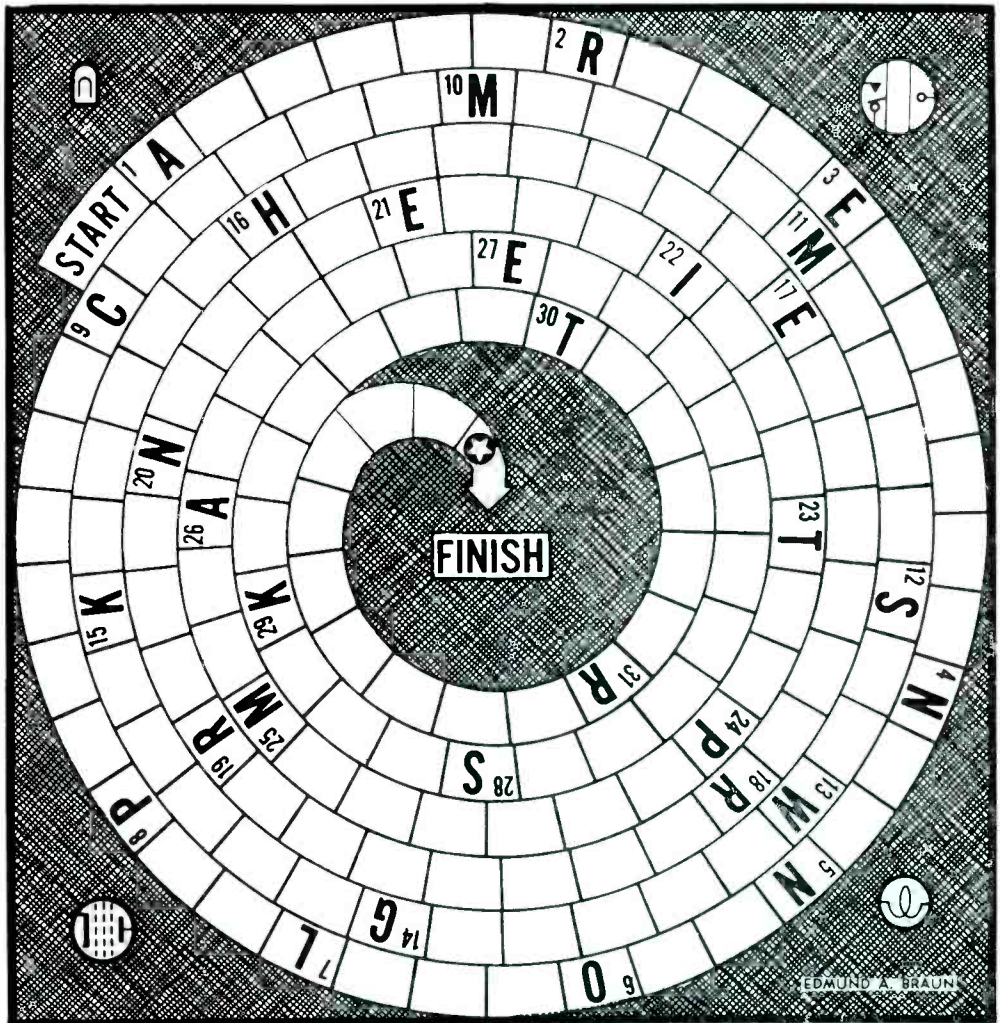

1. An instrument for measuring electric current.
2. Difference between the maximum and minimum value of a variable.
3. A single anode pool tube with means for maintaining a continuous cathode spot.
4. Invisible, colorless, odorless gas; atomic number 10, atomic weight 20.183.
5. Prefix meaning millimicro. (one billionth)
6. Type of tube base.
7. A device for producing light.
8. Pertaining to a synthetic resin used for insulating, etc.
9. A metallic element widely used to plate chassis, steel hardware, etc.
10. One million units of resistance.
11. Flanges, or means to connect or attach components.
12. White specks in TV picture caused by a weak signal.
13. Coil of wire in a transformer.
14. A small capacitor formed by twisting two insulated wires together.
15. Type of speaker enclosure designed for installation in the corner of a room.
16. Pertaining to a permanent magnet shaped like a U.
17. Licensed operator of a radio or TV station.
18. A parasitic antenna element located in other than the general direction of the major lobe of radiation.
19. The hardened secretion of some trees used in varnish, etc.
20. An instrument's indicating pointer.
21. A PN diode to which a large amount of impurity material has been added.
22. The driving force applied to a circuit or device.
23. A selective circuit that attenuates signals but does not affect desired ones.
24. One of the chemical elements; atomic number 78.
25. A transparent material often used as a dielectric for capacitors, etc.
26. A chemical compound used for coating recording discs, etc.
27. The decay of underground cable caused by stray electrical currents.
28. Sensory impression caused by an electric current.
29. Removable portion in the side of a box or cabinet easily removed with a hammer.
30. Small variable capacitor associated with another capacitor for fine adjustment.
31. Quantity of radioactive material producing one million disintegrations per second.

Circuit complete? Then please check our solution on Page 54.

Reports from the test lab

By Carl Babcoke

Each report about an item of electronic test equipment or a component is based on examination and operation of the device in the ELECTRONIC SERVICING laboratory. Personal observations about the performance, and details of new and useful features are spotlighted, along with tips about using the equipment for best results.

Solid-state curve tracers, in my opinion, have not received the acceptance from technicians that

they deserve. Although the tests take slightly longer than some, they also provide more useful information. So, I was glad to find Hickok had included a curve tracer in their new line of test equipment.

Hickok Curve Tracer For Solid-State

These are some features of the Model 440 Hickok solid-state curve tracer:

- A plastic-coated card with simplified instructions for connecting and using the tester can be pulled out

of the cabinet when needed; it's not necessary to keep the instruction book with the tracer after you have mastered the operation;

- Although out-of-circuit tests give the best accuracy, many in-circuit patterns can be obtained with only a slight distortion of the waveform (refer to the series on Jud Williams Signature Patterns in many of the 1973 and 1974 issues of ELECTRONIC SERVICING);

- A wider range of adjustments is provided, but set-up marks are included to get you in the "ball park" for most transistor tests; and
- The "INSTA BETA" display, exclusive to this model, shows most characteristics at a glance.

Connecting To A Scope

All curve tracers must have a scope readout, and the Hickok 440 makes it easy to connect your scope (Figure 1) by providing front panel banana jacks that are plainly labeled. Also, to allow changing the horizontal and vertical size of the scope display without the need to recalibrate the scope gains, two attenuation switches are supplied. Although it is not necessary to calibrate the gains of the scope in order to determine whether a transistor is good or bad, accurate measurements of beta do require precise calibrations, and the tracer supplies signals to permit setting both the vertical gain and the horizontal gain. The attenuation switches are well worth the extra cost.

Connecting Transistors

Parallel-wired sockets and banana jacks make possible the connection of all sizes of components, either in or out of circuit (Figure 2). Two sets of sockets/jacks are connected to the SELECTOR switch so matching of transistors can be done easily.



This is the Hickok Model 440 Semiconducting Curve Tracer, with the operation and set-up card extended.

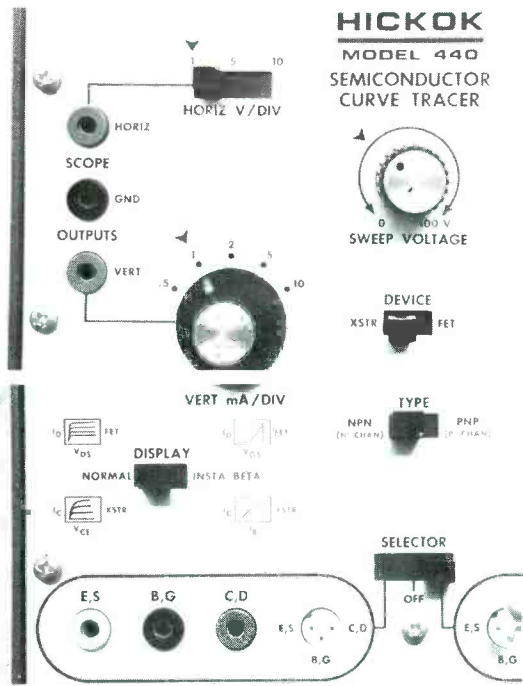

Fig. 1 The clearly-labeled banana jacks for connecting to the scope are located conveniently on the panel, along with the attenuation switches. The switches permit changing the size of the display, without upsetting the scope gain calibrations.

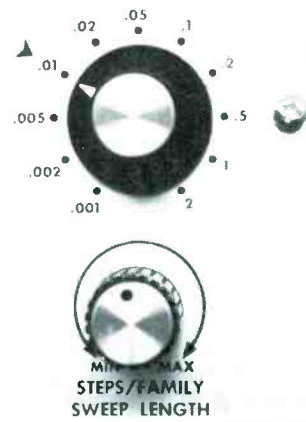
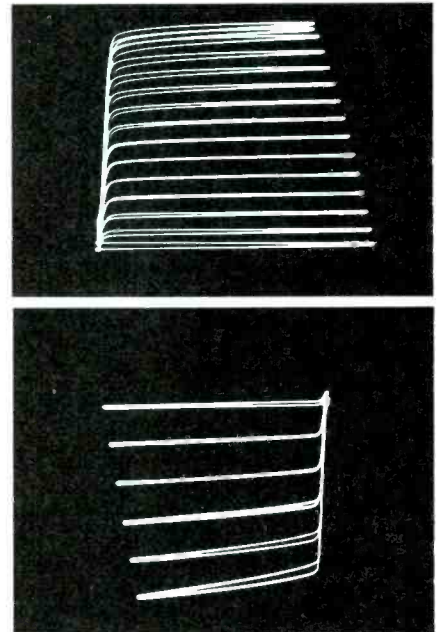

Fig. 2 Either of two sets of parallel-wired sockets and banana jacks can be switched in by the SELECTOR switch, when it is desirable to have a rapid comparison of two transistors.



Number Of Curves

One unique feature is supplied by the circuit and the STEPS/FAMILY SWEEP LENGTH control which allow you to select any number of curves between one and nine (plus the base line; see Figure 3). Actually, this individual tracer showed a maximum of fourteen plus the no-current base line. Other tracers are limited to five or seven curves plus the base line, and the number is not variable except to a limited extent by the application of excessive base bias to the transistor.

The ability to reduce the number of curves is quite important with occasional transistor defects that produce almost zero collector current (beta) at low forward biases, because the base current is not changed by the number of curves.

Insta Beta Curve

Another pattern I have never seen on any other curve tracer is the INSTA BETA (Figure 4). It is made by applying an almost-steady voltage to the collector, and feeding the base with a ramp (sawtooth), so the vertical part of the waveform represents collector current, and the horizontal deflection shows base current. Of course, DC beta is collector current divided by base current. Therefore, the number of vertical graticule spaces times the setting of the HORIZ V/DIV switch divided by the product of the

horizontal graticule spaces times the setting of the BASE-GATE GENERATOR switch equals the DC beta.

Summary

The Hickok Model 440 curve tracer (\$165 technicians price), when connected to your scope, provides family-of-curves measurements of gain, transconductance, breakdown voltage, saturation voltage, leakage, and zener breakdown for both transistors and FET's. Many of these tests can be made in circuit, as well. Zener, silicon, and germanium diodes also can be tested.

Special features include calibration voltages, attenuation switches, Insta Beta display, and an adjustable number of curves. □

Fig. 3 Base current per curve is selected by the BASE GENERATOR switch, and the number of curves is determined by the setting of STEPS/FAMILY SWEEP LENGTH control. The control is continuously adjustable, but the curves pop in or out with a complete one each time. The waveform with 14 curves plus the base line is from a silicon NPN low-gain transistor, while the other with five curves plus the base line represents a medium-gain germanium PNP transistor.

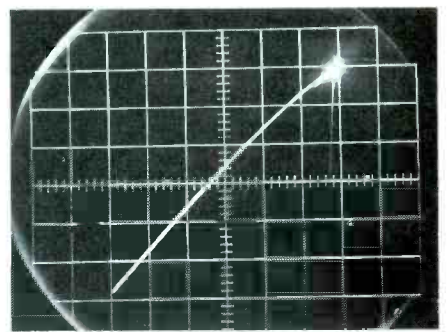
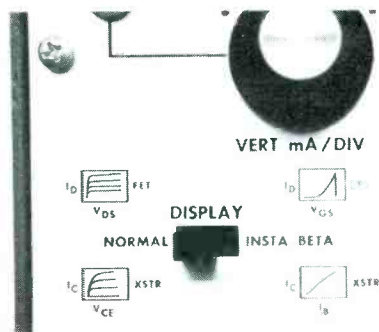

Fig. 4 A NORMAL/INSTA-BETA DISPLAY switch gives the choice of a family of curves or the single diagonal line of Insta Beta. The waveform is the Insta Beta display of a non-defective PNP germanium audio-type transistor, having a gain of about 90.

productreport

These features supplied by the manufacturers are listed at no-charge to them as a service to our readers. If you want factory bulletins, circle the corresponding number on the Reply Card and mail it to us.

Universal Tripler

A new component designed to replace 98% of all high-voltage triplers used in major brand TV sets is the VT-3 universal voltage tripler

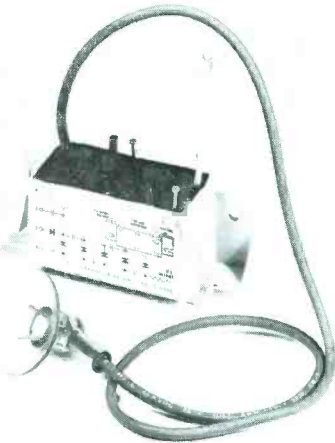

from Oneida Electronic which serves as a 6X6 tripler for most transistor-

ized horizontal-output systems, and as a 5X5 tripler for most vacuum-tube systems.

Complete installation instructions are included. Mounting can be either horizontal or vertical. Maximum output voltage is 35 KV.

For More Details Circle (50) on Reply Card

Adhesive Kit

No mixing is required for Bond-Fix and Bond Solv-Kit, from Workman Electronic Products. The adhesive sets almost immediately. A tube of Quik-Bond and syringe for easy application is included.

Model 33-102 is designed for use with glass, rubber, ceramics, metal, plastics, and synthetics.

For More Details Circle (51) on Reply Card

Fence Protection System

A single operator can monitor up to 6,000 feet of fence from a central office display with the fence protection system from GTE Sylvania. Featuring a 1/8-inch diameter coaxial cable which is attached to the fence to detect vibrations, the system uses advanced signal-processing techniques that help reduce false alarms caused by wind, rain, birds, and animals.

Signals generated by the sensing

cable are fed into a processing box, analyzed, and if the processor determines a person is present, an alarm is sounded on the central monitoring display and a blinking light indicates which section is threatened. The display also allows security personnel to hear sounds detected by the cable.

For More Details Circle (52) on Reply Card

"Power-Free"

Closed-Circuit TV Camera

Model CTC-2100 closed-circuit TV camera, which does not require a



power source at its location, is said to be capable of operating on a single coaxial cable, up to 2,000 feet away from its monitor.

Weighing less than 3 pounds with a

Computer-like accuracy in pricing!

That's the way Tech's Guide works! Like a computer. Tech's Guide contains mountainous quantities of work/time facts (7 years of "feed-in")

...you extract the job

pricing you want almost as easily as pressing a button. That's errorless pricing in the 19 major categories of repair...true and proper balance between cost and work performed. You can bank on it! Pricing calculator adjusts to any area in U.S. in seconds. Tech's Guide is in a professional, hard-use cover, 6-ring steel binding, fast-tab design, 7 1/2 x 9 1/2 size fits in the tool box...ready for immediate use. Thousands of shops, coast to coast, have proved its value. Order yours with the coupon, enclose check or money order. All orders filled same day.

tv & radio tech's guide to pricing

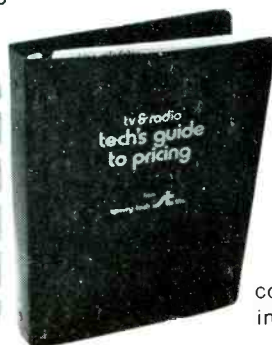

\$18⁰⁰ per issue, postpaid.

(Nebr. residents add city and state sales tax)

At several times the price.. it's really low-cost, cool-temper insurance in customer relations.

the guide with a brain builds trust.

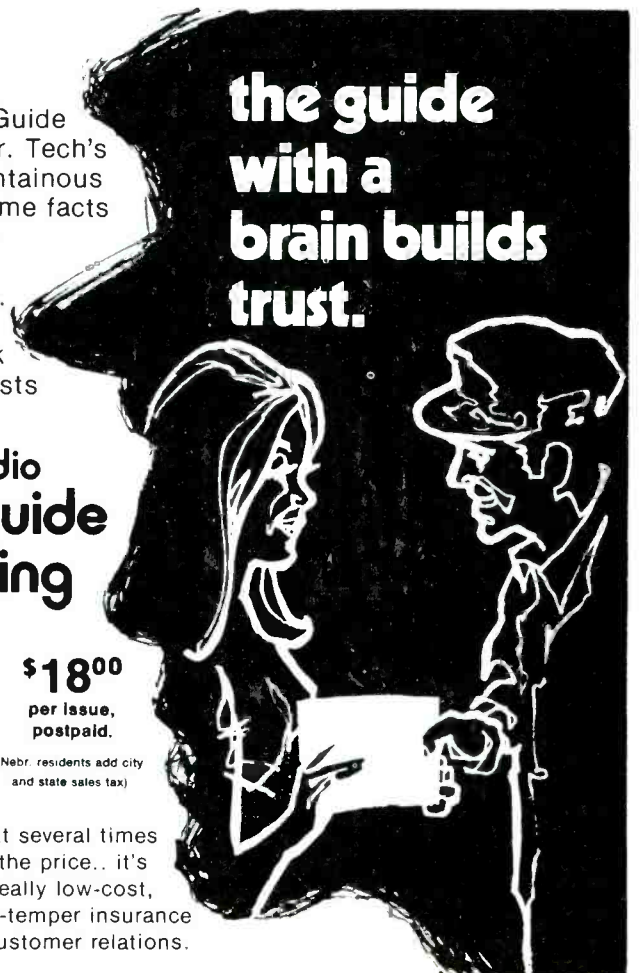

sperry tech inc.

P.O. Box 5234
Lincoln, NE 68505

- More information please.
 My check or money order enclosed.

NAME _____
COMPANY _____
ADDRESS _____
CITY _____ STATE _____ ZIP _____

For More Details Circle (9) on Reply Card

ELECTRONIC SERVICING

total length of 7-1/4 inches, the compact unit features automatic beam control and a built-in cable compensator.

The camera, marketed by **GBC Closed Circuit TV Corporation**, provides a high resolution of more than 600 lines, and features 12,000 to 1 automatic light compensation for instantaneous adjustment from almost total darkness to bright sunshine.

For More Details Circle (53) on Reply Card

Tuner Degreaser

Super Tun-O-Wash, developed by **Chemtronics Inc.** is said to provide 50% more degreasing power than the original Tun-O-Wash formula.

Reportedly effective in dissolving and flushing away grease, oil, corrosion, and dirt that accumulate on TV tuner contacts, the product also is recommended for use on tape recorders and record player mechanisms, motors, switches, relays, and contacts of all types.

Safe for plastics, Super Tun-O-Wash reportedly leaves no residue and causes no frequency drift. Chemtronics recommends that tuners be restored every 6 months.

A 12-ounce aerosol can is priced at \$2.40.

For More Details Circle (54) on Reply Card

Self-Contained Desoldering Tool

Universal Soldapullit is a compact self-contained unit that requires no external vacuum supply. Molten solder is vacuumed up by the simple thumb release of a high-capacity spring-loaded plunger. An adjustable loading feature permits loading stops to be placed in any of three positions for easy one-handed loading for a small, medium, or large size finger span.

For safety, the plunger movement is confined so that it does not extend beyond the body length of the tool. Compact and lightweight (1.6 ounces), the **Edsyn** tool is designed for simple trouble-free operation, low maintenance, and low cost.

An integral plunger shaft extension self-cleans the desoldering tip each time the tool is reloaded. The high-temperature Teflon tip can be removed easily for routine cleaning or replacement.

For More Details Circle (55) on Reply Card

Write and tell us what kind of articles you would like to see in **Electronic Servicing**

Antenna Action from **ACA**

JUMBO AC/747 FOR LONG HAULS

82 CHANNEL VHF-UHF FOR COLOR OR BLACK & WHITE

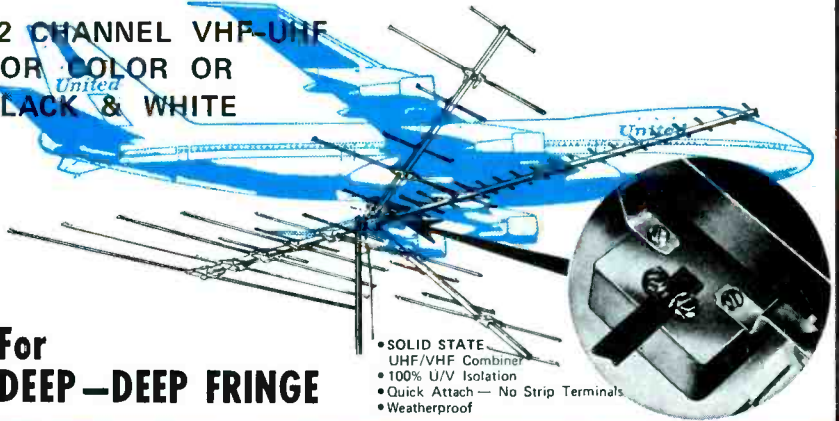

For DEEP-DEEP FRINGE

- SOLID STATE UHF/VHF Combiner
- 100% U/V Isolation
- Quick Attach — No Strip Terminals
- Weatherproof

JUMBO AC-747 for DEEP - DEEP FRINGE



- 48" VHF CORNER DIRECTOR SYSTEM
- 48" UHF Corner Reflector • 63 TOTAL ACTIVE ELEMENTS
- Boom Length 136" 22 Driven Elements
- Double Mast Clamp 31 Directors
- Includes UHF Power Pac 10 Reflectors
- Blue Boom — Gold Elements

DC10 for DEEP FRINGE

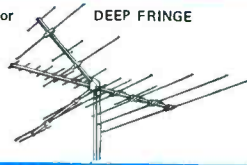

- 34" VHF CORNER DIRECTOR SYSTEM
- 34" UHF Corner Reflector • 43 TOTAL ACTIVE ELEMENTS
- Boom Length 78" 18 Driven Elements
- Double Mast Clamp 18 Directors
- Blue Boom — Gold Elements 7 Reflectors
- Correlator Phasing for Perfect Match and Increased Gain.

AC-727 for FRINGE AREA



- 28" VHF CORNER DIRECTOR SYSTEM
- 28" UHF Corner Reflector • 35 TOTAL ACTIVE ELEMENTS
- Boom Length 60" 14 Driven Elements
- 13 Directors
- 8 Reflectors
- Correlator Phasing for Perfect Match and Increased Gain.
- Blue Boom — Gold Elements

POWER PAC PP800 For Additional UHF Gain For DC10 and 727

- 10 Additional UHF Directors for DC10 & 727.

ACA

P.O. Box 865, Highway 61 North Burlington, Iowa 52601

LINE UP TODAY WITH ACA!

SEE YOUR DISTRIBUTOR OR WRITE

For More Details Circle (10) on Reply Card

VTVM ACCURACY IN YOUR POCKET.

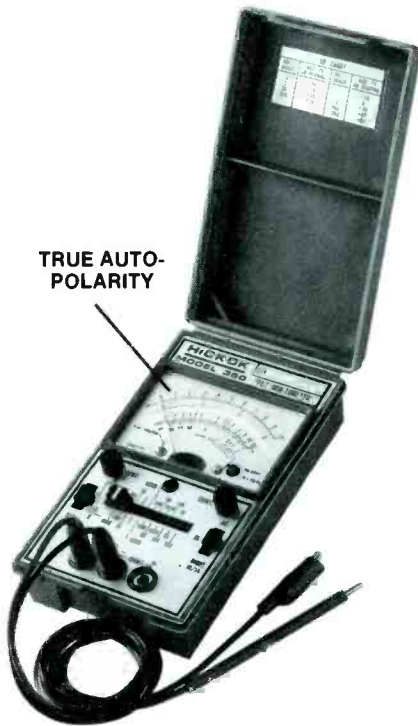

The Hickok Model 350 Pocket FET Multimeter combines bench top accuracy in a pocket-sized portable package for troubleshooting sensitive solid state circuits.

- Full VTVM type ranges and 10 megohm input impedance
- Foolproof overload protection
- Simplified quick-reading meter; 3 scales plus db and battery condition

There's a lot more to the Model 350, including our unique 2-year warranty. Ask your Hickok distributor for full details or contact us.

\$119⁰⁰

HICKOK

the value innovator

INSTRUMENTATION & CONTROLS DIVISION
THE HICKOK ELECTRICAL INSTRUMENT CO.
10514 Dupont Avenue • Cleveland, Ohio 44108
(216) 541-8060 • TWX: 810-421-8286

For More Details Circle (11) on Reply Card

test equipment report

These features supplied by the manufacturers are listed at no-charge to them as a service to our readers. If you want factory bulletins, circle the corresponding number on the Reply Card and mail it to us.

Industrial Maintenance and Appliance Tester

Special features of the WV-531A industrial maintenance and appliance tester from RCA include an LED probe for continuity checks, an immersible thermistor probe for temperature measurements, and a special AC current-leakage test for shock hazards.

For easy point-to-point continuity checks of switches, wiring, fuses, and terminal blocks, the LED probe simply lights if there is continuity; there is no need for repeated reference to the meter reading.

The thermistor probe features accuracy, ruggedness, and fast response; less than one minute is normal for an accurate reading.

An AC current-leakage test for shock hazards is included for checking leakage on exposed metal parts of

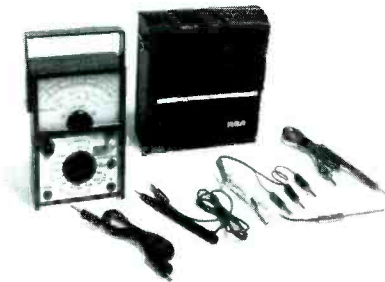

tools, appliances, TV sets, motors, and other equipment.

Two 1.5 volt penlite batteries are required for operation of the \$89.00 unit.

For More Details Circle (56) on Reply Card

Portable Dual-Trace Scope

Model D32 dual-channel Telequipment oscilloscope offers 10-MHz bandwidth, and vertical sensitivity ranging from 10 mV/div to 5V/div in 9 calibrated steps.

Other features include flexible triggering, automatic selection of chopped or alternate modes, and a choice of battery or AC line operation. Batteries, probes, and molded front-panel protective cover are standard equipment.

The D32 weighs only 10 pounds and can be carried either by its 3-position handle or by an optional carrying case

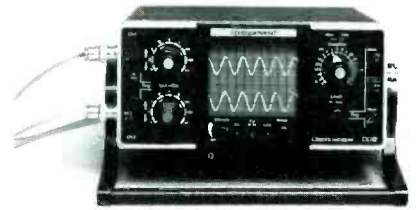

with a shoulder strap.

From Tektronix, the scope is priced at \$995.00.

For More Details Circle (57) on Reply Card

Power-Outlet Tester

H. H. Smith, Inc. offers the AC Fault Finder #3030, a device for testing the voltages and wiring of

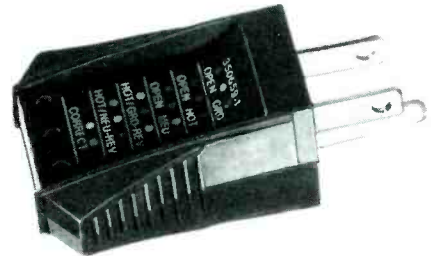

3-prong AC outlets which have a ground wire. Old-type duplex outlets also can be tested by the addition of a polarized adapter and a ground wire. Illumination of the indicators shows "correct", "open hot", "open neutral", "open ground", "hot/ground reversed" or "hot/neutral reversed".

Price is \$5.95 each, and standard packaging is 12 to a container.

For More Details Circle (58) on Reply Card

Pushbutton Yoke, Flyback Tester

The YF33 Ringer, Yoke, and Flyback Tester is two instruments in one. Any yoke or flyback can be tested in seconds, in or out of circuit, in tube or solid-state sets. Model YF33 also is a complete sweep-circuit analyzer with peak-to-peak, and high-voltage tests for troubleshooting any horizontal-output section.

Designed for portable use or on-the-bench application, the YF33 from Sencore is priced at \$195.00.

For More Details Circle (59) on Reply Card

**Ideas for articles?
Send them to ES, now!**

Color-Pattern Generator

Chroma-Line Model 432 generator provides 16 "Touch Command" patterns through the use of a 4X4 push-button selector matrix, located on the front panel. **Simpson Electric Company** used the latest digital large-scale integration (LSI) technology in the Chroma-line for better stability and reliability. Five channel outputs are provided: 3 VHF channels and 2 UHF channels.

Additional features of the \$179.00 unit include a composite video output, vertical and horizontal sync output, a built-in cable-storage compartment, 75-ohm coax and 300-ohm impedance-matching transformer (balun) outputs, and red, blue, and green gun killers.

Model 432 generator is supplied complete with cable assemblies for 75-ohm coax and 300-ohm inputs, and an operator's manual.

For More Details Circle (60) on Reply Card

Battery-operated and encased in rugged leather with an accessory compartment, the FSM-3 also features a built-in speaker, which eliminates



closing the cover automatically turns off the battery power.

For More Details Circle (61) on Reply Card

Hook-On Test Probe

Designed to reach into dense wiring areas for safe, sure contact, the "Hookon" test probe hooks onto leads, pins, and square wire-wraps by the use of a fingertip slide control, which includes a self-locking open position and tensioned "no-hands" spring-grip trigger release.

Model 3070 accepts and adapts to banana plugs, phone tips, and test prods, as well as wire. Featuring sturdy Lexan construction and a

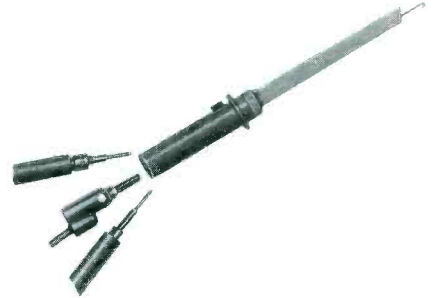

corrosion-resistant, steel contact lead, the product is available from **Herman H. Smith, Inc.**, for \$3.00.

For More Details Circle (62) on Reply Card

Portable Signal-Level Meter

Blonder-Tongue's FSM-3 is a moderately-priced (\$290.00) solid-state, portable signal-level meter featuring an ohmmeter range of 0 to 1000 ohms to check risers for opens, shorts, and proper terminations.

the need for earphones when identifying sound on TV channels or FM stations.

Continuous coverage is provided for both UHF and VHF bands, and the taut-band meter reads directly in dBmV to show the signal levels. Model FSM-3 has a safety switch;

FOR TIGHT SPOTS!



CHAPMAN

Midget RATCHET SETS
plus ADAPTERS

18°
Working
Arc

CATALOG
AVAILABLE



-
-
-
-
-

Designed to function in confined space, Chapman Tools are a must for anyone who deals with small to medium size screws, bolts and nuts. Economy priced sets are available in a wide range of assortments covering Allen Hex, Metric Hex, Slotted, Phillips, Bristol and Reed and Prince sizes. Ratchet requires only 18° work ark. Screwdriver Handle and Extension included.

POCKET SIZED
ECONOMY PRICED KITS

KIT No. 6320 only \$13.60

Write! . . . THE CHAPMAN MANUFACTURING COMPANY
DURHAM, CONNECTICUT 06422 Dept. ES-9

For More Details Circle (12) on Reply Card

September, 1975

J
8



You can study FM two-way radio at home!

Thousands have increased their knowledge of FM two-way radio through the MTI home-study courses. Now, newly revised and better than ever!

Cut me in, send free information. (No salesman will call)

Name _____
Address _____
Code _____

I am a Veteran I am a serviceman on active duty



Formerly

MOTOROLA TRAINING INSTITUTE

College Hill Road, Summerdale, Pennsylvania 17093

For More Details Circle (13) on Reply Card

49

audio systems report

These features supplied by the manufacturers are listed at no-charge to them as a service to our readers. If you want factory bulletins, circle the corresponding number on the Reply Card and mail it to us.

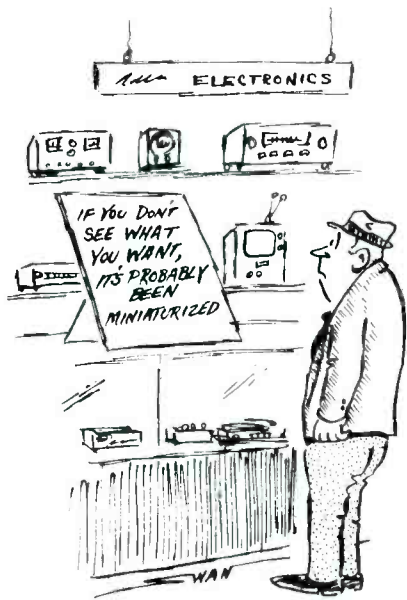

Phono Cartridge

The M95ED phono cartridge features a new thinner uninterrupted pole piece designed to optimize magnetic characteristics, especially at high frequencies. According to **Shure Brothers**, magnetic losses are minimized, and frequency response remains essentially flat across the entire frequency range.



With its nude-mounted, biradial elliptical stylus tip, the M95ED has a very low effective stylus tip mass which is said to result in higher trackability to maintain perfect groove contact through even heavily-modulated passages. The \$59.95 unit is designed to track at between 3/4- to 1-1/2 grams.

For use with heavier tracking turntables and tone arms, Shure offers the M95EJ cartridge, which retails for \$44.95.

For More Details Circle (63) on Reply Card

Trim-Cut Splicers

Two new models of the "Gibson Girl" splicer with the trim-figure cut

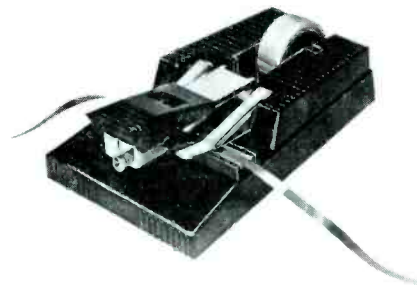

have been introduced by **Robins Industries**. Each model is designed to

produce a slight trim cut on edges of spliced tape to help keep adhesive from contacting critical parts of the tape deck.

A knob with cut and trim positions is featured. Spring-loaded arms lock down to hold tape in position. The cutting blades, protected by rubber pads, are exposed only when splicing. A vibration-proof blade adjustment is provided.

Model R26038 is designed for 1/4-inch reel-to-reel and 8-track tape. Cassette tapes are handled by Model R33047. Each model lists for \$8.50.

For More Details Circle (64) on Reply Card

Stereo Speaker Sets

RCA has introduced three stereo-speaker sets. Model 12R401D features a 4.6-ounce ceramic magnet that drives a voice coil compatible with 4- to 8-ohm systems. Frequency response of the speaker is 50 Hz to 10,000 Hz with a sensitivity of 93 decibels.

The speaker can be flush-mounted, and is priced at \$14.85 a pair.

Model 12R405 "Big Mag" speaker set consists of two matched 6-inch by 9-inch oval cone speakers with a 12-ounce ceramic magnet, and rated power input of 10 watts. Frequency response of the speakers is 50 Hz to 15,000 Hz. The speakers are \$22.95 a pair, and are compatible with 3- to 8-ohm impedance tape players and radios. All necessary hardware, plus 24 feet of speaker wire is provided.

The "Super Mag" set has all the features of the 12R405 plus a heavy-duty 21.2-ounce ceramic magnet for high-efficiency sound reproduction. Model 12R406 is priced at \$29.95 per pair.

For More Details Circle (65) on Reply Card

Heavy-Duty Replacement Speakers

Speakers designed to withstand heat, moisture, and high-volume operation (for example, in tractors) are available from **Quam-Nichols**. Special weatherproofing of the cone and a soft vinyl surround provide durability.

All these speakers have voice-coil impedances of 8 ohms, and are rated at 15 watts. List prices range from \$13.50 to \$15.20, depending on the size.

For More Details Circle (66) on Reply Card

Multi-Purpose Amplifiers

Bell P/A Products Corporation has a new heavy-duty line of economically-priced audio amplifiers for applications in background music, intercom paging, or public address.

Models T-300 (30 watts), T-600 (60

THE NLS LM-3 VOLKSMETER

World's lowest priced precision digital multimeter -- more accurate and rugged than the old pointer meter -- ideal for field service.



With rechargeable batteries and charger unit

\$125

Standard Features:

- Automatic polarity and zeroing. • Large 0.33" LED display. • 13 ranges: vac, vdc & ohms with 1% accuracy. • Size: 1.9"H x 2.7"W x 3.9"D.
- LM-3 basic meter also available in four digits with 0.02% accuracy. Ask for LM-4.

See your local distributor!

Distributor inquiries invited.



Non-Linear Systems, Inc.

Originator of the digital voltmeter.

Box N, Del Mar, California 92014

Telephone (714) 755-1134 TWX 910-322-1132

For More Details Circle (14) on Reply Card

watts) and T-1400 (140 watts) feature four high-impedance microphone inputs (which can be ordered with broadcast-type Mumetal-shielded transformers for balanced low-impedance operation), bass and treble tone controls, a dual auxiliary input, aluminum construction to minimize heating,



2N type silicon transistors, and an automatic protection circuit with indicator light to prevent damage to the amplifier from overloads or speaker-line shorts.

For More Details Circle (67) on Reply Card

Pedestal Loudspeaker

Sound West's Tower I is both functional and decorative. Featuring a

solidly-built enclosure, phase-locked double 8-inch high-compliance bass-speaker system, and 2-inch cone driver, the system is capable of handling up to 50 watts of continuous program material.

Standing 37-inches tall and 10-inches wide and deep, with a frequency response of 34-20,000 Hz and 8-ohms impedance, the system retails for \$119.95.

For More Details Circle (68) on Reply Card

Extended Range Speaker System

The Shure SR108 is an extended range, two-way speaker system designed for high volume reproduction of wide frequency-range program material in sound reinforcement applications. The system uses a tuned port, horn-loaded low-frequency section, and a high-frequency section consisting of four compression drivers coupled to a radial horn. The SR108 has an EIA sensitivity rating of 54 dB.

Frequency response is said to be peak-free from 40 Hz to 15,000 Hz. The \$597.00 system can be used for rugged field applications, is equipped for biamp operation, and handles high

level program material, reportedly with complete safety from burnout.

For More Details Circle (69) on Reply Card

Two-Way Phone Amplifier

Model FTA-100 two-way telephone voice amplifier from the Fanon/Courier Corporation features both automatic voice-controlled switching from send to receive, and manual override.



The unit does not require installation; simply place the handset in the acoustical receptacle, and adjust the receive sensitivity and volume. □

For More Details Circle (70) on Reply Card

Your comments and ideas are welcome.

skinny DIP CLIP

DESIGNED TO TEST HIGH DENSITY INTEGRATED PACKAGES

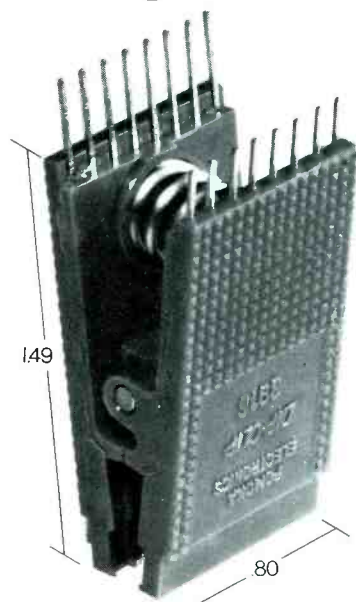

Count on Pomona Electronics to keep pace with the industry's trend toward high density Dual In-Line packaging. We've slimmed down our Model 3916 DIP test clip 1/8th of an inch so you can now test two adjoining high density-mounted 16-pin DIP's at the same time. Unique new design features 0.025" square pins to accept wire-wrap receptacles. Friction grip contacts improve holding power. And it's a great DIP remover too!

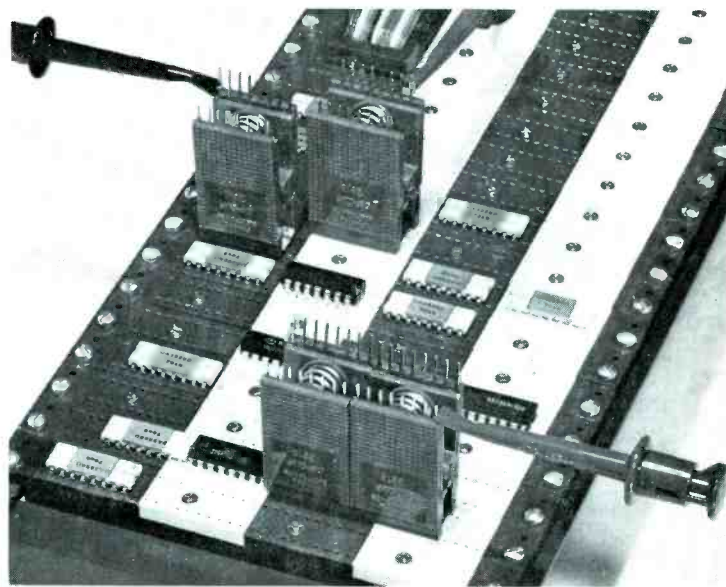

Original wide body DIP CLIP shown at rear for size comparison.



POMONA ELECTRONICS

A Division of ITT

1500 East Ninth St., Pomona, California 91766 Tel: (714) 623-3463

SOLD ONLY THROUGH ELECTRONIC DISTRIBUTORS

More chances to be right

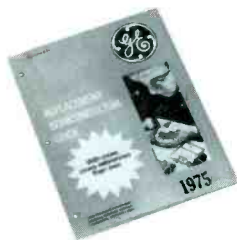

Thousands more cross references



Transistor kit for foreign sets

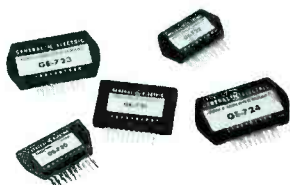

Replacement amplifier modules



All the help you need at your authorized distributor

Tube Products Department
General Electric Company
Owensboro, Kentucky 42301

GENERAL ELECTRIC

catalogs literature

Circle appropriate number on Reader Service Card.

100. RCA—offers a pocket-sized manual featuring the RCA line of car-stereo products. Illustrations, features and benefits, and technical specifications of car-stereo players, speakers and accessories are described.

101. Mouser Electronics—manual #803 lists low-cost components, production aids, and test accessories complete with specifications, illustrations, and pricing information. The products listed include: Sanwa precision multimeters, tantalum capacitors, ultra-miniature toggle switches, 1/8-watt carbon-film resistors, batteries, knobs, semiconductors, wide-view panel meters, variable and isolation transformers, PC drafting aids, electronic chemicals, tools, and hardware.

102. Heath—The Heathkit catalog describes over 350 kits for nearly every do-it-yourself interest ranging from TV, radio, stereo and 4-channel hi-fi, to fishing, marine, R/C models, home appliances, electronic organs, automotive, test instruments, and others.

103. Klein—presents an 80-page catalog of specialized professional hand tools. Organized for easy reference and indexed both alphabetically and by product number, the catalog includes a selection of pliers, wrenches, screwdrivers, saws, hammers, levels, measuring tapes and rules, and many specialized electrical and electronic work tools, plus belts, tool pouches, and pockets. Tools and safety equipment are illustrated with large photographs and drawings.

104. Brookstone Company—makes available a 68-page catalog featuring hundreds of products sold rarely by industrial distributors or found in stores. The collection of products includes hard-to-find hand tools and small power tools. A year's free subscription (six issues) is offered.

105. Precision Electric Company—offers a general catalog which describes their line of soldering equipment. Soldering irons, holders, tool and accessory kits, tips, aids, and pots are included. Size and heat specifications, and details of construction and materials are given.

106. Blonder-Tongue—makes available TV antenna-system layouts as a free design service to help improve dealer showroom systems. Information such as the number of channels in the area, number of TV sets on demonstration in the store, and a diagram of the store layout indicating where the sets are located must be filled out on a TV-Showroom Layout-Request Form. When the form is returned, the B-T engineering department will custom-design an MATV system for the dealer showroom, and provide a price quote on what a new or upgraded system would cost.

107. International Rectifier—the Maintenance, Repair, and Operations catalog lists replacement components for industrial electronics equipment including germanium, silicon and selenium rectifiers, zener diodes, bridges, SCR's, protective devices and semiconductor fuses, switches and relays. Charts give complete specifications including voltage range, current rating, case style, and price information. □

IT'S NO PUZZLE TO ORDER



OELRICH SERVICE FORMS
FOR TV-RADIO & 2 WAY RADIO SERVICE LEGAL FORMS FOR CALIF. FLA. UTAH NOW AT YOUR PARTS JOBBER OR WRITE FOR CATALOG B64
OELRICH PUBLICATIONS
4040 N. NASHVILLE AVE. CHICAGO, ILLINOIS 60634

For More Details Circle (16) on Reply Card

FREE ALARM CATALOG

Huge selection of burglar & fire systems, supplies. Motion detectors, infrared beams, controls, door switches, bells, sirens. 500 items, 99 pp. packed with technical details, notes.
(Outside U.S., send \$1.00.)
mountain west alarm
4215 n. 16th st., phoenix, az. 85016



For More Details Circle (17) on Reply Card

APPLIANCE REPAIR BOOKS

Written in easy-to-understand language by experts with illustrations & diagrams. Acclaimed by instructors & professionals. How to diagnose & repair air conditioners, refrigerators, vacuum cleaners, ranges, washers, dryers, steam irons, portable kitchen appliances, water heaters; plus how to set up a shop, using test instruments and more. Only \$2.65 to \$4.90 each!

SEND FOR FREE DESCRIPTIVE PRICE LIST
C & N, DEPT. ES, 5841 MONTROSE, CHICAGO 60634

For More Details Circle (18) on Reply Card

bookreview

Home TV-FM Antennas

Author: Paul Lawrence, Hansen Elroy
Publisher: Howard W. Sams & Co., Inc., 4300 West 62nd Street, Indianapolis, Indiana 46268
Size: 208 pages, book number 21076
Price: \$5.95 paperback

All phases of antenna installation for TV and FM receivers in the home reportedly are covered in this book. Signal transmission and reception are discussed, followed by a chapter on selecting the antenna with relationship to distance, terrain, and interference. Photographs and diagrams are used to familiarize the technician with a variety of antennas, towers, mounts, amplifiers, accessories, and installation procedures. The function and adjustment of TV receiver controls are explained. The authors discuss receiver location, appliance noise, RF interference, signal overload, and FM-receiver considerations. Other topics discussed include antenna theory, lead-in loss, choosing the proper lead-in, rotators, antenna amplifiers and preamplifiers, tools required for installation, and antenna system design.

Contents: Types of Antennas; Antenna Selection; Antenna Towers; Antenna Lead-In; Rotators; Antenna Amplifiers and Accessories; TV and FM Receivers; Installation; System Design.

Color TV Servicing, Third Edition

Author: Walter H. Buchsbaum
Publisher: Prentice-Hall, Inc., Englewood Cliffs, New Jersey 07632
Size: 270 pages, book number 152397
Price: \$10.95 hardbound

This third edition of Color TV Servicing has been updated to include the newest techniques, circuits, and components. Some of the subjects covered are: simplified step-by-step procedures for installing the color set and antenna; time-saving techniques for making various special color alignments; new methods for quick troubleshooting of any receiver type; modern ways to easily correct interference problems and intermittent defects; and important new material on integrated circuit and transistor configurations and new color picture tubes. Buchsbaum includes 10 pages of color plates to demonstrate defects in the color receiver, and more than 140 diagrams and illustrations to help aid the technician in servicing older sets as well as the most recent TV receivers. □

the bright one

new phosphor picture tube
with twice the brightness

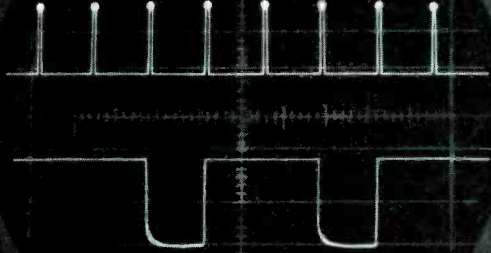

TO-60 automatic dual-trace triggered-sweep oscilloscope

P-31 phosphor CRT has double the brightness for bright displays even in high speed dual-trace modes. Bandwidth: DC to 15 mhz. Unique features for the industry's greatest value are: • Automatic Triggering • Automatic Astigmatism • Automatic Horizontal Sweep • Automatic Horiz/Vert. TV Triggering provides positive display on composite video signals. Vertical sensitivity: .01 volts/cm to 20 volts/cm in 1-2-5 step sequence. Horizontal Sweep Speeds: .2 sec/cm to .5 μ sec/cm in 1-2-5 step sequence. Has 5X magnifier at all sweep speeds. External Horiz. Amp. Bandwidth: DC to .5 mhz; Sensitivity: .5 volts/cm. Calibrated Test Signal: 1 volt P-P square wave. Power: 105-125 volts, 60 cycles, 65 watts

Model TO-60 Less Probes. Net \$489.50

TO-55 automatic single-trace triggered sweep oscilloscope. Features same as TO-60 except Vert. Bandwidth is DC to 10 mhz.

Model TO-55 Less Probes. Net \$379.50

For the "bright one," see your distributor, or write:



LECTROTECH, INC.

5810 N. Western Avenue, Chicago, Illinois 60659
Area (312) 769-6262

For More Details Circle (19) on Reply Card

The MARKETPLACE

This classified section is available to electronic technicians and owners or managers of service shops who have for sale surplus supplies and equipment or who are seeking employment or recruiting employees.

Advertising Rates

in the Classified Section are:

- 25 cents per word (minimum \$3.00)

- "Blind" ads \$2.00 additional

- All letters capitalized 35 cents per word

Each ad insertion must be accompanied by a check for the full cost of the ad.

Deadline for acceptance is 30 days prior to the date of the issue in which the ad is to be published.

This classified section is not open to the regular paid product advertising of manufacturers.

FOR SALE

NEW Canadian Magazine "Electronics Workshop". \$5.00 yearly. Sample \$1.00. Ethko, Box 741, Montreal "A" Canada. 10-74-12t

UNUSUAL SURPLUS AND PARTS Catalog. \$1. ETCO Electronics Dept. E.S., Box 741, Montreal "A" H3C 2V2. †2-74-12t

DISCOUNTS TEST EQUIPMENT, parts. B&K, Sencore, RCA. B&K model 1246 color bar generator reg. \$156.00, now only \$132.60. Pomona 30KV high voltage probe \$29.95. Others, list 10. F&M Electronic Dist., P.O. Box 236, Dept. K, Masp. Qns., N.Y. 11378. 6-75-4t

ELECTRONIC 8 digit calculator: 25 keys, (\$3.00) refundable: durable, Tayo Paul, 980 Greene Avenue, Brooklyn, NY. 11221. 7-75-3t

DON'T JUNK THAT T.V.—We have the most complete stock of T.V. picture tubes in U.S. B & W and color, old or new, over 1700 types at the lowest prices. ALLIED SALES, Pimento, Indiana 47866, 812-495-5555. 8-75-3t

CONVERT any transistorized T.V. tuner to a tuner substituter. Plans \$2.00. New accelerated Radio & T.V. course. RADIO TELEVISION TRAINING, Box 279, ES-85, Syracuse, N.Y. 13206. 8-75-1f

HOW TO SAVE money on tuner repairs. Information \$2.00. TIP\$, Bruce, Miss. 38915. 8-75-2t

REPAIR your own TV. Valuable information \$2.00. TIP\$, Bruce, Miss. 38915. 8-75-2t

PF REPORTER/ELECTRONIC SERVICING Nov. 1962 thru present. Four volumes missing. Make offer. Don Graybill, 1724 Munson St., Camarillo, CA. 93010. 9-75-1t

HELP WANTED

NOTE: Employment ads which violate Equal Opportunity Employment provisions will not be accepted.

EXPERIENCED Field Technician Wanted. Salary depends on experience. Send resume to Miller's Radio Shack, Inc. 801 Texas, Goodland, Kansas 913-899-2386 9-75-1t

EDUCATION-INSTRUCTION

REPAIR TV TUNERS—High Earnings; Complete Course Details, 12 Repair Tricks, Many Plans, Two Lessons, all for \$2. Refundable. Frank Bocek, Box 3236 Enterprise, Redding, Calif. 96001. 6-75-4t

TV PROBLEMS?? Send symptoms with a copy of schematic and self-addressed stamped envelope and \$1.00 to Troubleshooter, Box 4553, Downey, Ca. 90241. Results Guaranteed. 9-75-1f

WANTED

WANTED: Used Tuner Repair Course. C. W. Hume, 108 Hillcrest Circle, Greenville, S.C. 29609 9-75-1t

BUSINESS OPPORTUNITY

IN CENTRAL ONTARIO. Established radio, TV and electronics service shop, fully equipped. \$35,000.00. Reply to Dept. 506, Electronic Servicing, 1014 Wyandotte St., Kansas City, Mo. 64105. 8-75-2t

advertisers' index

American Technology Corporation	.. 13
Antenna Corp. of America 47
B & K Div., Dynascan Corp. 7
Bussmann Mfg. Div., McGraw-Edison 27
Castle TV Tuner Service, Inc.	.. Cover 4
Chapman Manufacturing 49
Charous & Niebergall 52
Chemtronics, Inc. 9
Cleveland Institute of Electronics 35, 36
Gem City Tuner 12
General Electric Company 52
Heath Company Cover 3
Hickok Electrical Instrument Co.	... 48
Lectrotech, Inc. 53
Mallory Distributor Products 3
Motorola Training Institute 49
Mountain West Alarm Supply Co.	... 52
Non-Linear Systems 50
Oelrich Publications 52
Pomona Electronics 51
Precision Tuner Service Cover 2
RCA Distributor and Special Products 17
RCA Distributor and Special Products 1
Sperry Tech, Inc. 46
GTE Sylvania - Consumer Renewal 10, 11
Tuner Service Corporation 5
Weller-Xcelite, Inc. 25

(Continued from Page 43)

Solution to: ELECTRONIC MERRY-GO-ROUND PUZZLE

- | | |
|----------------|------------------|
| 1. AmmeteR | 16. HorseshoE |
| 2. RangE | 17. EngineeR |
| 3. ExcitroN | 18. ReflectoR |
| 4. NeoN | 19. ResiN |
| 5. Nano- | 20. NeedIE |
| 6. OctaL | 21. EsakI |
| 7. LamP | 22. InpuT |
| 8. Phenolic | 23. TraP |
| 9. CadmiuM | 24. PlatinuM |
| 10. MegohM | 25. MicA |
| 11. MountS | 26. AcetatE |
| 12. SnoW | 27. ElectrolysiS |
| 13. WindinG | 28. Shock |
| 14. Gimmick | 29. KnockouT |
| 15. KlipschH | 30. Trimmer |
| 31. Rutherford | |

Start with 124 points and deduct 4 points for any part you may not have answered correctly.

Your rating:

- | | |
|---------|------------------|
| 60-68 | Pretty good. |
| 72-84 | Very good. |
| 88-96 | Very, very good. |
| 100-120 | Excellent! |
| 124 | PERFECT! |

You get the brass ring!



"But when you said it was a diagonal color TV I thought you meant..."

Four good reasons to buy your next scope from Heath.

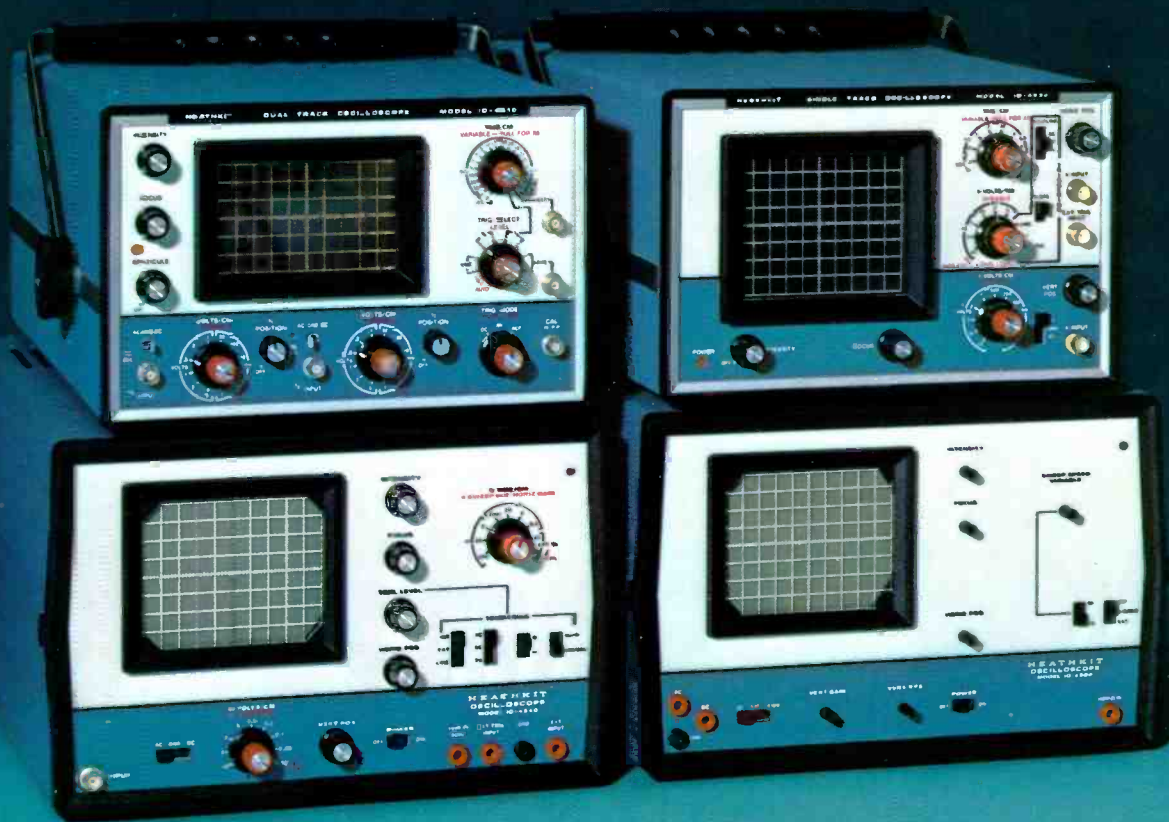

Looking for a low cost oscilloscope with performance and features that will make it more than just a "visual voltmeter"? Well, your search is over. Heath has a new family of scopes that offer more performance per dollar than the industry has seen in years.

Our 4510 is a dual trace 15 MHz scope that can display high-speed waveforms without losing the leading edge. Both vertical inputs have delay lines for complete waveform display. Sensitivity is 1 mV over the entire bandwidth — and it will typically trigger on signals up to 45 MHz! Other features include post-accelerated CRT for brighter trace and faster writing speeds... trace X-Y operation... and easy-to-service design. And the best part is the low price. Only \$569.95* kit, \$775.00* assembled.

Heath's 4530 sets a new standard for single trace scopes. And it's easy to see why. The DC-10 MHz bandwidth, sensitive 10 mV input and TV coupling give you real versatility at a low price. It's one of the few single trace scopes available with two input channels — a calibrated X-input is provided for X-Y operation. Trigger circuits are digitally controlled, requiring

only level control and slope switch adjustments. \$299.95* kit, \$420.00* assembled.

The 4540 is probably the best general purpose triggered scope value available today. It can quickly provide an accurate display of any waveform from DC to 5 MHz. Vertical input sensitivity is 20 mV with nine calibrated attenuator positions up to 10 V/cm. Special TV coupling allows the 4540 to easily trigger on TV signals, making it an even more valuable service tool. Only \$179.95* kit, \$275.00* assembled and calibrated.

The Heathkit 10-4560 now makes it possible for everyone to have a high performance scope. It offers DC-5 MHz bandwidth, 103 mV sensitivity, automatic triggered sweep from 20 ns to 200 ns/cm, external horizontal input. A great low-cost scope for general design and service work for the unbelievably low price of \$119.95*.

Get complete information and specs on the above scopes, and all Heath instruments, in our latest Heathkit and Assembled Instruments catalogs. You may not be aware of what Heath instruments can do for you — and how little they cost. After all, we're not the industry standard... yet.

HEATH
Schlumberger

Heath Company
Dept. 511-090
Benton Harbor, Michigan 49022

Please send: My free Heathkit Catalog.
 My free Assembled Instruments Catalog.

HEATH COMPANY, Dept. 25-09 Benton Harbor, Michigan 49022

NAME _____

ADDRESS _____

CITY _____ STATE _____ ZIP _____

*MAIL ORDER PRICES, F.O.B. FACTORY.
PRICES AND SPECIFICATIONS SUBJECT TO CHANGE WITHOUT NOTICE.

EK-469

For More Details Circle (7) on Reply Card

You enjoyed the **TIMESAVING** advantages of the previous models of the Castle Subber® analyst . . . **NOW** you will want to move up to this superior, redesigned model . . . our best yet!

SUBBER®

Mark IV-CUV

**UHF-VHF tuner
and i-f analyst**

net \$64.95



If you haven't joined the ranks of thousands of professional technicians using this **TIMESAVING** instrument . . . **NOW** is your opportunity to own the latest model boasting these improved features:

- **TUNES ALL VHF & UHF CHANNELS.** Use where prime signals are on either VHF or UHF . . . or both.
- **ELECTRONIC FINE TUNING.** Smooth, exact tuning ensures precise setting for ease in testing color receivers.
- **DUAL 40MHz IF OUTPUT JACKS.** Select Hi or Lo impedance output for best coupling match to circuit being substituted . . . tube or transistor.
- **BATTERY CONDITION INDICATOR.** IC comparator driven LED shows when inbuilt 9v transistor batteries require replacement. Battery & 120-vac line powered.

The Mark IV-CUV tunes all 82 VHF & UHF channels for substitution tests of the tuners and entire i-f system of any 40MHz TV receiver. Permits signal injection after the agc controlled stages for the high speed agc system analyzing procedure invented by Castle . . . the first practical method for analyzing agc system defects without confusion.

Mark IV-C

The Mark IV-C tunes all 12 VHF channels for substitution injection tests of the VHF tuner, UHF tuner and entire i-f system of any 40MHz TV receiver.

- **ELECTRONIC FINE TUNING.**
- **DUAL 40MHz IF OUTPUT JACKS.** Battery & 120-vac line powered.
- **BATTERY CONDITION INDICATOR.**

net \$54.95



Made in USA.

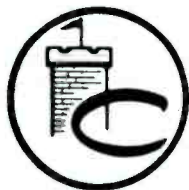

See your stocking distributor . . . or write for more details and complete specifications.

CASTLE TV TUNER SERVICE, INC.

5701 N. Western Ave., Chicago, Illinois 60645 Phone: (312) 561-6354

For More Details Circle (8) on Reply Card